

MAE[®]

Catálogo 2025



ÍNDICE

Herramientas 01

Engrapadoras	02
Grapas	08
Desengrapadores	09
Perforadoras	09
Guillotina	12
Despachadores de cinta	12
Etiquetadora	13
Etiquetas	13
Foliadores	14
Tabla de corte	15
Cuchillas	16
Cutters	16
Reglas	17
Ábacos	18
Compases	19
Juegos de geometría	20
Sacapuntas	20
Tijeras	30
Calculadoras	34

Cintas y adhesivos 35

Lápices adhesivos	36
Micas	37
Cintas	38
Película autoadherible transparente	43
Película autoadherible de colores	44
Película decorativa	46

Sujetadocumentos 47

Sujetadocumentos	48
Clips	49
Broches	50
Broches latonados	50
Tachuelas	51
Pines	51
Protectores de hojas	52

Accesorios de escritura 53

Gomas	54
Entrenador	60
Correctores	61
Lápiz de grafito	63
Lápiz de dibujo	64
Lápices de colores PREMIUM	65
Lápices de colores	66
Lápiz duo y colores doble punta	68
Lápices checadores	69
Crayones	70
Tempera	72
Plumas	73
Notas adhesivas y de índice	74

Polipropileno 85

Fabric	86
Coloursenses	89
Licencia Crack & Bonky	92
Sobres con hilo	94
Sobres con cierre	97
Sobres con broche	98
Folders	99
Carpeta con palanca	102
Cubiertas para encuadernar	104
Arillos para encuadernar	106
Bolsas para regalo	106

Suplementos de oficina 109

Ligas de hule	110
Ligas de colores	111
Portagafetes	112
Yoyos	114
Tablas plásticas	115
Tablas MDF	117
Tablas de aluminio	118
Bandejas	119
Organizadores	121
Llaveros	124
Indicadores láser	125
Pizarrón de tela y organizadores	126
Organizadores mesh	127
Cajas para archivo	130
Sillas de oficina	131
Sillas de plástico	131
Marcos de aluminio	132

Arte y manualidades 133

Pinceles para óleo	134
Pinceles para acuarela	136
Pinceles escolares	138
Pistolas para silicón	140
Silicón en barra	140
Silicón líquido	141
Diamantina con pegamento	142
Pegamento blanco	144
Diamantina entera	145
Diamantina fina	146
Limpiapipas	148
Limpiapipas metálicos	149
Pompones	150
Tijeras con patrón de corte	151
Chaquira, chaquirón y canutillo	152
Lentejuela	153
Cuenta dona	154
Ojitos	154
Foamy	155
Foamy diamantado	156
Foamy iridiscente	157
Fieltro	157

HERRAMIENTAS

Engrapadoras

MEM-26

Mini engrapadora con **saca grapas integrado**, para grapas estándar de 24/6 y 26/6. Engrapa hasta **16 hojas**.



Colores:



Interno: 24 pzas.
Corrugado: 288 pzas.



7 502265 168066

MEM-26N

Mini engrapadora color **negro** con **saca grapas integrado**, para grapas estándar de 24/6 y 26/6. Engrapa hasta **16 hojas**.



Interno: 24 pzas.
Corrugado: 288 pzas.



7 502265 168325

MEM-2640

Mini engrapadora plástica para grapas del número 26/6, incluye **640 grapas**.



Colores:



Interno: 12 blisters.
Corrugado: 216 blisters.



7 502286 765237

MEK-10

Mini engrapadora plástica para grapas del número 10, incluye **1000 grapas**.



Colores:



Interno: 24 blisters.
Corrugado: 192 blisters.



7 502212 171330

MEK-26

Mini engrapadora plástica para grapas del número 26/6, incluye **1000 grapas**.



Colores:



Interno: 24 blisters.
Corrugado: 144 blisters.



7 502212 171279

MEK-2640

Mini engrapadora plástica para grapas del número 26/6, incluye **640 grapas**.



Colores:



Interno: 12 blisters.
Corrugado: 216 blisters.



7 502286 765220

Engrapadoras

EMM-5

Engrapadora metálica **compacta** de **media tira**, con cubierta suave, para grapas estándar de 26/6. Engrapa hasta **20 hojas**.



Interno: 24 pzas.
Corrugado: 96 pzas.



7 502212 171354

EMM-5S

Engrapadora metálica **satinada compacta**, de **media tira**, con cubierta suave, para grapas estándar de 26/6. Engrapa hasta **20 hojas**.



Interno: 24 pzas.
Corrugado: 96 pzas.



7 502212 176687

EMM-10

Engrapadora metálica de **media tira** con cubierta suave, para grapas estándar de 26/6. Engrapa hasta **20 hojas**.



Interno: 12 pzas.
Corrugado: 72 pzas.



7 502212 171286

EMM-10S

Engrapadora metálica **satinada** de **media tira**, con cubierta suave, para grapas estándar de 26/6. Engrapa hasta **20 hojas**.



Interno: 12 pzas.
Corrugado: 72 pzas.



7 502212 172368

EMT-10

Engrapadora metálica de **tira completa** con cubierta suave, para grapas estándar de 26/6. Engrapa hasta **20 hojas**.



Interno: 12 pzas.
Corrugado: 48 pzas.



7 502212 171293

EMT-10S

Engrapadora metálica **satinada** de **tira completa**, con cubierta suave, para grapas estándar de 26/6. Engrapa hasta **20 hojas**.



Interno: 12 pzas.
Corrugado: 48 pzas.



7 502212 172375

Engrapadoras

EPM-20M

Engrapadora de **plástico** para grapas estándar de 26/6.
Media tira. Engrapa hasta 20 hojas.



Interno: 12 pzas.
Corrugado: 96 pzas.



7 502277 580221

EPM-20T

Engrapadora de **plástico** para grapas estándar de 26/6.
Tira completa. Engrapa hasta 20 hojas.



Interno: 12 pzas.
Corrugado: 72 pzas.



7 502277 580238

EPE-5

Engrapadora de **plástico** para grapas estándar de 26/6.
Media tira. Engrapa hasta 20 hojas.



Interno: 12 pzas.
Corrugado: 288 pzas.



7 502286 767958

EPE-5C

Engrapadora de **plástico** para grapas estándar de 26/6.
Media tira. Engrapa hasta 20 hojas. Colores surtidos



Interno: 12 pzas.
Corrugado: 288 pzas.



7 502286 767965

EPE-10M

Engrapadora de **plástico** para grapas estándar de 26/6.
Media tira. Engrapa hasta 20 hojas.



Interno: 12 pzas.
Corrugado: 144 pzas.



7 502286 767972

EPE-10T

Engrapadora de **plástico** para grapas estándar de 26/6.
Tira completa. Engrapa hasta 20 hojas.



Interno: 12 pzas.
Corrugado: 72 pzas.



7 502286 767989

Engrapadoras

EPC-20

Engrapadora de **pinza cromada**, para grapas de 26/6.
Engrapa hasta **25 hojas**.



Interno: 30 pzas.
Corrugado: 60 pzas.



7 502237 306229

EMP-10

Engrapadora de **pinza metálica**, de tira completa para
grapas de 26/6. Engrapa hasta **20 hojas**.



Interno: 12 pzas.
Corrugado: 48 pzas.



7 502212 176700

EMT-20

Engrapadora metálica de **tira completa**, para grapas
estándar de 26/6. Engrapa hasta **20 hojas**.



Interno: 12 pzas.
Corrugado: 48 pzas.



7 502212 172719

EES-MT

Engrapadora de **uso suave media tira**, para grapas estándar
de 26/6. Engrapa hasta **20 hojas**.



Interno: 12 pzas.
Corrugado: 48 pzas.



7 502237 300029

EES-TC

Engrapadora de **uso suave tira completa**, para grapas
estándar de 26/6. Engrapa hasta **25 hojas**.



Interno: 6 pzas.
Corrugado: 36 pzas.



7 502237 300036

Engrapadoras

EMG-M

Engrapadora de golpe metálica, media tira, para grapas de 26/6. Engrapa hasta 20 hojas.

Colores:



Interno: 12 pzas.
Corrugado: 48 pzas.



7 502265 168042

EMG-T

Engrapadora de golpe metálica, tira completa, para grapas de 26/6. Engrapa hasta 20 hojas.

Colores:



Interno: 12 pzas.
Corrugado: 36 pzas.



7 502265 168059

ME-12C

Mini engrapadora cromada, para grapas estándar de 24/6 y 26/6. Engrapa hasta 12 hojas.



Interno: 24 pzas.
Corrugado: 432 pzas.



7 502277 580245

EMC-M

Engrapadora cromada de media tira con tacones antiderrapantes, para grapas estándar 24/6 y 26/6. Engrapa hasta 25 hojas.



Interno: 12 pzas.
Corrugado: 72 pzas.



7 502277 581556

EMC-T

Engrapadora cromada de tira completa con tacones antiderrapantes, para grapas estándar 24/6 y 26/6. Engrapa hasta 25 hojas.

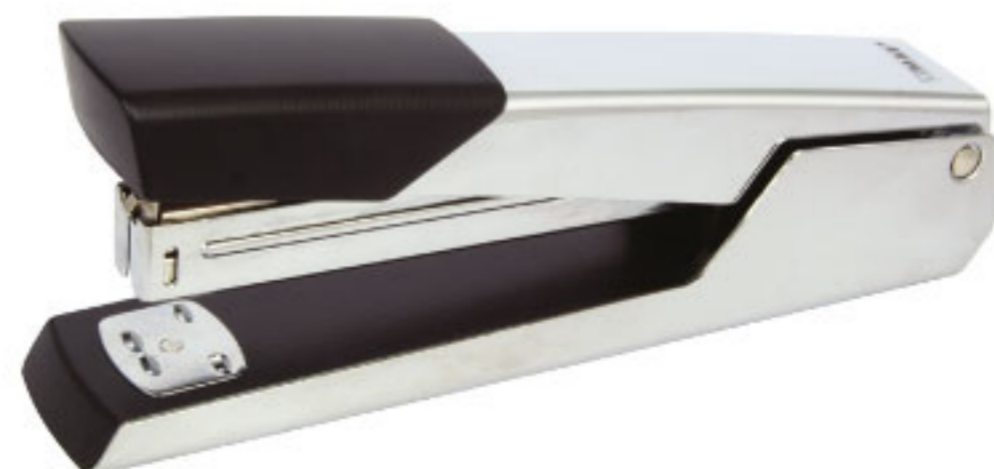

Interno: 12 pzas.
Corrugado: 48 pzas.



7 502277 580252

Kits y engrapadoras

KMAE1

Kit de engrapadora metálica de **media tira**, desengrapador y 5000 grapas.



Interno: 12 kits.
Corrugado: 24 kits.



7 502237 306175

KMAE2

Kit de engrapadora metálica de **tira completa**, desengrapador y 5000 grapas.



Interno: 12 kits.
Corrugado: 24 kits.



7 502212 175925

EUP-2

Engrapadora de **uso pesado**. Utiliza grapas de 26/6 y 5/16. Capacidad de engrapado: **50 hojas**.



Interno: 1 pza.
Corrugado: 24 pzas.



7 502212 172610

EUP-4

Engrapadora de **uso pesado**. Utiliza grapas de 26/6, 5/16 y 1/2. Capacidad de engrapado: **100 hojas**.



Interno: 1 pza.
Corrugado: 12 pzas.



7 502212 172603

EUP-8



Engrapadora de **uso pesado**. Utiliza grapas de 26/6, 23/10, 23/13, 23/15, 23/17, 23/20 y 23/23. Capacidad de engrapado: **220 hojas**.



Interno: 1 pza.
Corrugado: 12 pzas.



7 502237 302313

EMT-10GL

Engrapadora de **garganta larga** con tope de plástico, para grapas de 24/6 y 26/6. Engrapa hasta **20 hojas**.



Interno: 1 pza.
Corrugado: 24 pzas.



7 502212 179824

Grapas

GR-5000

Grapa estándar de 26/6. Caja con 5000 piezas.



Interno: 20 cajas.
Corrugado: 100 cajas.



GR-1000 #26/6

Grapa estándar de 26/6. Caja con 1000 piezas.



Interno: 20 cajas.
Corrugado: 600 cajas.



GR-1000 #10

Grapa del número 10. Caja con 1000 piezas.



Interno: 20 cajas.
Corrugado: 800 cajas.



GR-1000 #5/16

Grapas de 8 mm para uso pesado.
Capacidad de engrapado de 30 a 50 hojas.
Caja con 1000 piezas.



Interno: 20 cajas.
Corrugado: 240 cajas.



GR-1000 #3/8

Grapas de 10 mm para uso pesado.
Capacidad de engrapado de 50 a 70 hojas.
Caja con 1000 piezas.



Interno: 20 cajas.
Corrugado: 200 cajas.



GR-1000 #1/2

Grapas de 13 mm para uso pesado.
Capacidad de engrapado de 70 a 100 hojas.
Caja con 1000 piezas.



Interno: 15 cajas.
Corrugado: 150 cajas.



Grapas, desengrapador y perforadoras

GR-1000 #3/4

Grapas de 20 mm para uso pesado.
Capacidad de engrapado de 160 a 190 hojas.
Caja con 1000 piezas.



Interno: 20 cajas.
Corrugado: 120 cajas.



7 502212 174461

GR-1000 #15/16

Grapas de 23 mm para uso pesado.
Capacidad de engrapado de 190 a 220 hojas.
Caja con 1000 piezas.



Interno: 20 cajas.
Corrugado: 120 cajas.



7 502212 174454

DES-15

Desengrapador plástico con uñas de metal y seguro,
para grapas del No. 10, 24/6 y 26/6.



Interno: 12 pzas.
Corrugado: 480 pzas.



7 502212 171316

DES-25

Desengrapador plástico con uñas de metal, para grapas
del No. 10, 24/6 y 26/6.



Interno: 12 pzas.
Corrugado: 480 pzas.

PM2A-78

Perforadora de 2 orificios ajustable a 7 y 8 cm.
Perfora hasta 25 hojas.

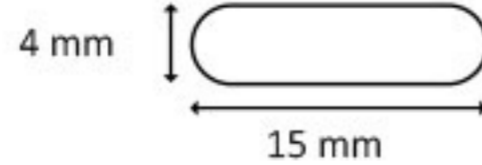

Interno: 1 pza.
Corrugado: 48 pzas.



7 502212 179848



Interno: 12 pzas.
Corrugado: 48 pzas.



7 502265 169490

Perforadoras

P-1



Perforadora metálica de **1 orificio**.
 Medidas:
 P-1 6 mm (1/4")
 P-1CH 3 mm (1/8")
 P-1MCH 1.5 mm (1/16")



Interno: 24 pzas.
 Corrugado: 192 pzas.

P-1



P-1CH



P-1MCH



PM2-CH

Perforadora metálica de **2 orificios** con 8 cm de distancia entre sí. Capacidad de perforado: **10 hojas**.



Interno: 24 pzas.
 Corrugado: 96 pzas.



PM2-M

Perforadora metálica de **2 orificios** con 8 cm de distancia entre sí. Capacidad de perforado: **20 hojas**.



Interno: 12 pzas.
 Corrugado: 48 pzas.



PM2-G

Perforadora metálica de **2 orificios** con 8 cm de distancia entre sí. Capacidad de perforado: **30 hojas**.



Interno: 1 pza.
 Corrugado: 24 pzas.



PM2-GX

Perforadora metálica de **2 orificios** con 8 cm de distancia entre sí. Capacidad de perforado: **40 hojas**.



Interno: 1 pza.
 Corrugado: 24 pzas.



Perforadoras

P2S-10

Perforadora de **2 orificios** con 8 cm de distancia entre sí, con **palanca suave**. Capacidad de perforado: **10 hojas**.



Interno: 24 pzas.
Corrugado: 96 pzas.



P-2HD70

Perforadora metálica de **2 orificios** con 8 cm de distancia entre sí. Para **uso pesado**. Capacidad de perforado: **70 hojas**.



Interno: 1 pza.
Corrugado: 12 pzas.



P2S-20

Perforadora de **2 orificios** con 8 cm de distancia entre sí, con **palanca suave**. Capacidad de perforado: **20 hojas**.



Interno: 12 pzas.
Corrugado: 48 pzas.



P-2HD190

Súper perforadora de **2 orificios** de 6 mm de diámetro y 8 cm de distancia entre sí. Para **uso pesado**. Capacidad de perforado: **190 hojas**.



Interno: 1 pza.
Corrugado: 6 pzas.



P2S-40

Perforadora de **2 orificios** con 8 cm de distancia entre sí, con **palanca suave**. Capacidad de perforado: **40 hojas**.



Interno: 1 pza.
Corrugado: 24 pzas.



P-3HD100

Perforadora metálica de **3 orificios**. Para **uso pesado**. Capacidad de perforado: **100 hojas**.



Interno: 1 pza.
Corrugado: 4 pzas.



Perforadoras, guillotinas y despachadores de cinta

P-3

Perforadora metálica de 3 orificios ajustables.
Capacidad de perforado: 10 hojas.



Interno: 1 pza.
Corrugado: 24 pzas.



7 502212 171187

D-10

Despachador de cinta chico, para cintas de hasta 19 mm x 33 m.



Interno: 1 pza.
Corrugado: 48 pzas.



7 502212 171910

GPO-15

Guillotina plástica de 15" x 12".



Interno: 1 pza.
Corrugado: 10 pzas.



7 502237 306236

D-20

Despachador de cinta mediano, para cintas de hasta 19 mm x 33 m.



Interno: 1 pza.
Corrugado: 24 pzas.



7 502212 171323

GPO-15M

Guillotina metálica de 15" x 12".



Interno: 1 pza.
Corrugado: 6 pzas.



7 502286 764308

D-30

Despachador de cinta grande, para cintas de hasta 24 mm x 68 m. Carrete grande y chico.



Interno: 1 pza.
Corrugado: 12 pzas.



7 502212 171897

Etiquetadora y etiquetas

DE-40

Despachador de cinta de empaque.



Interno: 1 pza.
Corrugado: 24 pzas.



EP8-30

Etiquetadora de 8 dígitos. Puede etiquetar fechas: 22/11/10, precios: \$00.0 y horas: 8:00. Dígitos del 0 al 9 y otros símbolos. Utiliza etiqueta 21 x 12 mm.



Interno: 25 pzas.
Corrugado: 50 pzas.



ETP-550

Etiqueta auto adherible para etiquetadora de precios empaque con 10 rollos de 550 etiquetas. Medida de la etiqueta 21 x 12 mm.



Interno: 1 pza.
Corrugado: 24 pzas.

ETP-550B



ETP-550AM



ETP-550NA



ETP-550RS



ETP-550VE



Foliadores

NUM-6

Numerador de 6 dígitos con cuerpo de metal.
Tipografía de 4 mm.



Interno: 12 pzas.
Corrugado: 240 pzas.



7 502277 580016

FEM-5

Fechaador con cuerpo de metal y banda de años hasta el 2032. Tipografía de 5 mm.



Interno: 12 pzas.
Corrugado: 480 pzas.



7 502277 580009

FOM

Foliador de 6 dígitos.

Foliador de 7 dígitos.

Foliador de 8 dígitos.



Interno: 1 pza.
Corrugado: 20 pzas.

FOM-06



7 502212 178551

FOM-07



7 502212 178568

FOM-08



7 502212 178575

Tabla de corte

TPC

Tapete de corte con guía cuadrículada, en colores verde/gris, el material no se deforma o rompe tras el corte. En tamaño A4 (30x20 cm), A3 (45x30 cm) y A2 (60x45 cm), grosor de 3 mm con 5 capas.

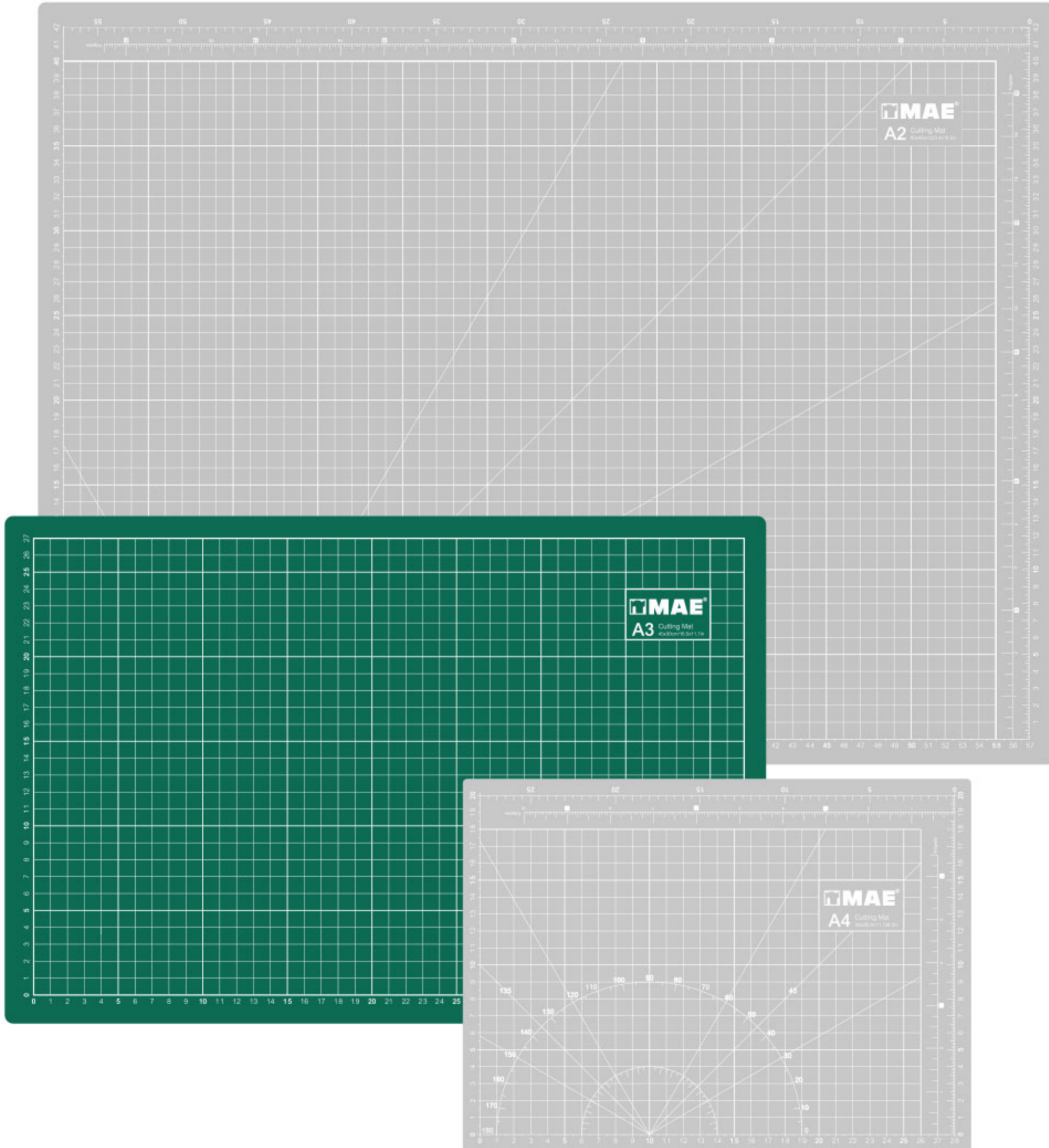

 Interno: 1 pza.
 Corrugado: 24 pzas.

TCP-A2

 7 502286 767118

 Interno: 1 pza.
 Corrugado: 42 pzas.

TCP-A3

 7 502286 767101

 Interno: 1 pza.
 Corrugado: 72 pzas.

TCP-A4

 7 502286 767095

Cuchillas y cutters

RCC-9

Cuchillas de repuesto para cutter, 9 mm. Hoja de acero inoxidable. Caja con 10 estuches de 10 piezas c/u.



Interno: 20 cajas.
Corrugado: 60 cajas.



7 502265 169780

CMC-24

Cutter metálico, caja exhibidora con 24 piezas.



Interno: 1 caja.
Corrugado: 10 cajas.



7 502237 301866

RCC-18

Cuchillas de repuesto para cutter, 18 mm. Hoja de acero inoxidable. Caja con 10 estuches de 10 piezas c/u.



Interno: 10 cajas.
Corrugado: 20 cajas.



7 502265 169773

CAM-CH

Cutter chico cuerpo plástico y alma metálica. Medida de la navaja 9 mm.



Colores:



Interno: 60 pzas.
Corrugado: 1,200 pzas.



7 502265 161777

CMU-100

Cuchilla multiusos de un solo filo, hoja de acero. Caja con 100 piezas.



Interno: 10 cajas.
Corrugado: 50 cajas.



7 502265 169797

CAM-G

Cutter grande cuerpo plástico y alma metálica. Medida de la navaja 18 mm.



Colores:



Interno: 48 pzas.
Corrugado: 480 pzas.



7 502265 161784

Cutters y reglas

CP-CH

Cutter cuerpo de plástico. Cuchilla de 9 mm.



Colores:



Interno: 24 pzas.
Corrugado: 720 pzas.



7 502265 169698

CP-G

Cutter cuerpo de plástico. Cuchilla de 18 mm.



Colores:



Interno: 24 pzas.
Corrugado: 288 pzas.



7 502265 169681

CPAM-CH

Cutter cuerpo de plástico con alma de metal, en blíster. Cuchilla de 9 mm.

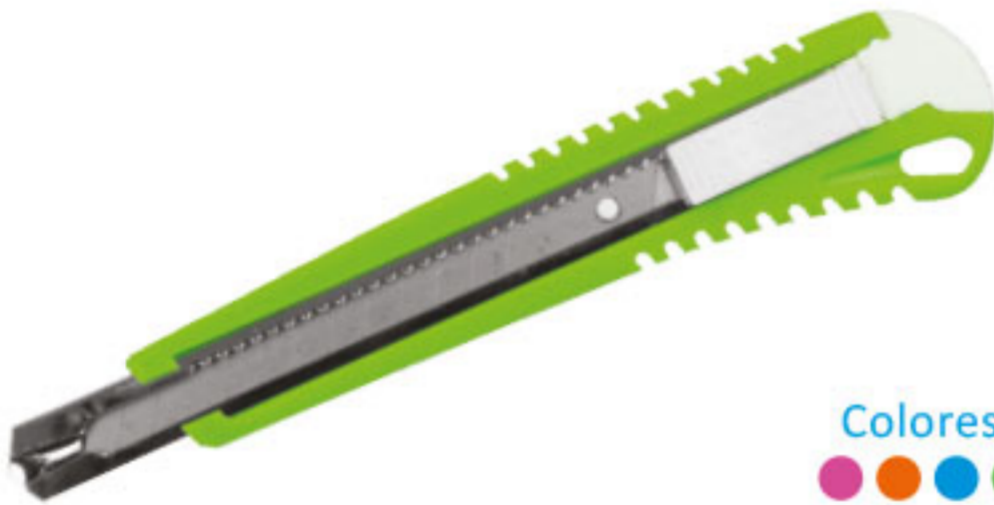

Colores:



Interno: 24 blisters.
Corrugado: 576 blisters.



7 502265 169759

CPAM-G

Cutter cuerpo de plástico con alma de metal, en blíster. Cuchilla de 18 mm.



Colores:



Interno: 12 blisters.
Corrugado: 240 blisters.



7 502265 169742

MCP-20BL

Mini cutter de plástico en colores brillantes. Blíster con 20 piezas.



Colores:



Interno: 12 blisters.
Corrugado: 48 blisters.



7 502265 169766

RF-30A

Regla de metal de 30 cm.

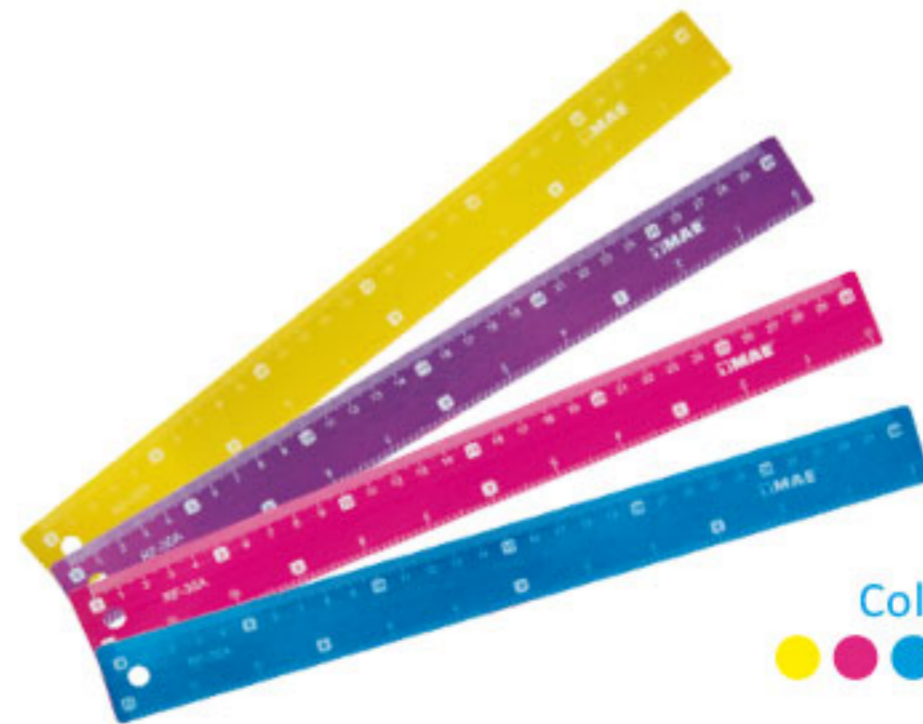

Colores:



Interno: 48 pzas.
Corrugado: 576 pzas.



7 502265 165713

Reglas y abacos

RF-20

Regla plástica flexible de 20 cm.



Colores:
● ● ● ● ●



Interno: 48 pzas.
Corrugado: 720 pzas.



7 502265 161371

RF-30

Regla plástica flexible de 30 cm.



Colores:
● ● ● ● ●



Interno: 48 pzas.
Corrugado: 432 pzas.



7 502265 161388

ACH

Ábaco chico, cuerpo y cuentas de plástico, en colores surtidos.



Corrugado: 120 pzas.



7 502286 765152

AGD

Ábaco grande, cuerpo y cuentas de plástico, en colores surtidos.



Corrugado: 80 pzas.



7 502286 765176

ACH-5

Ábaco chico, cuerpo y cuentas de plástico, en colores surtidos. Paquete con 5 piezas.

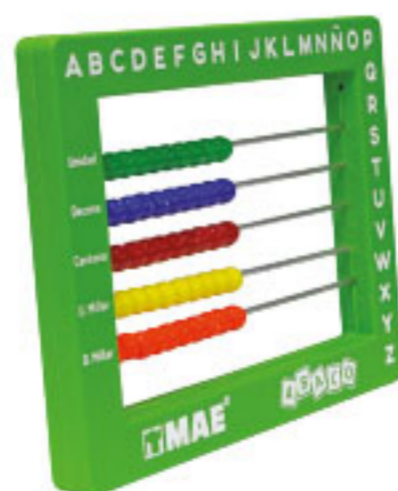

Corrugado: 24 paquetes



7 502286 765169

AGD-5

Ábaco grande, cuerpo y cuentas de plástico, en colores surtidos. Paquete con 5 piezas.

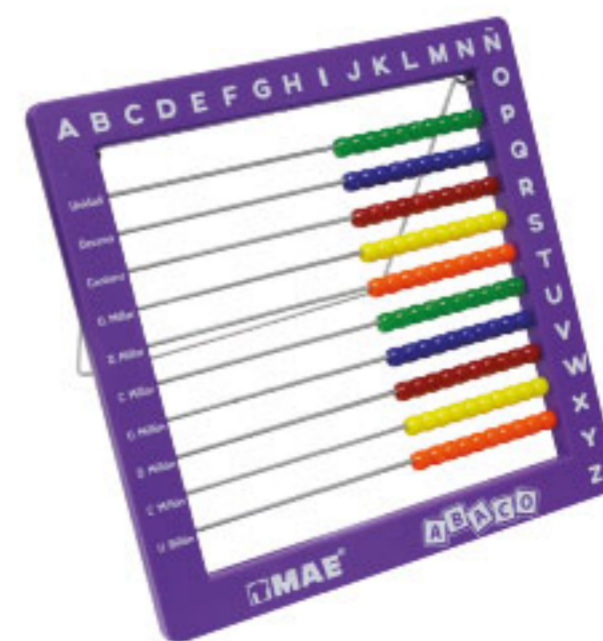

Corrugado: 16 paquetes.



7 502286 765183

Compases

CEP-10

Compás plástico escolar con lápiz, en blíster.



Colores:



Interno: 12 blisters.
Corrugado: 288 blisters.



7 502212 174232

CBL

Compás plástico escolar bicolor, en bolsa.



Colores:



Interno: 48 piezas.
Corrugado: 576 piezas.



7 502277 588456

CEL-10

Compás metálico escolar con lápiz.



Interno: 12 pzas.
Corrugado: 288 pzas.



7 502212 173525

CPP-2

Compás plástico de precisión, en blíster. Con minas de repuesto.



Colores:



Interno: 12 blisters.
Corrugado: 288 blisters.



7 502265 169667

CPA-20

Compás de precisión premium con accesorios, teclas de ajuste rápido y patas articuladas.



Interno: 10 pzas.
Corrugado: 80 pzas.



7 502237 307622

COP-10

Compás metálico de precisión con goma y repuestos de minas.



Interno: 12 pzas.
Corrugado: 120 pzas.



7 502212 172771

Juego de geometría y sacapuntas

JGF-M

Juego de geometría flexible tamaño mediano, con regla de 30 cm, escuadra de 45° y 60°, con compás.



Juego de geometría

SUPER Flexible **Con minas**

Colores:



Interno: 10 pzas.
Corrugado: 20 pzas.



7 502277 586926

JGF-G

Juego de geometría flexible tamaño grande, con regla de 30 cm, escuadra de 45° y 60°, con compás.



Juego de geometría

SUPER Flexible **Con minas**

Colores:



Interno: 10 pzas.
Corrugado: 20 pzas.



7 502277 586933

SMR-24

Sacapuntas rectangular metálico. Caja con 24 piezas.



Interno: 1 caja.
Corrugado: 60 cajas.



7 502237 304539

SMT-24

Sacapuntas triangular metálico. Caja con 24 piezas.



Interno: 1 caja.
Corrugado: 60 cajas.



7 502237 304546

SMT2-12

Sacapuntas doble metálico. Caja con 12 piezas.



Interno: 1 caja.
Corrugado: 60 cajas.



7 502237 305000

SPE-20

Sacapuntas de escritorio con cuerpo plástico y afilador metálico.



Interno: 12 pzas.
Corrugado: 48 pzas.



7 502212 172726

Sacapuntas

SSS-25

Sacapuntas de plástico colores sólidos. Bolsa con 25 piezas.



SSC-25



SSS-25



SSL-25



SSF-25



Interno: 60 bolsas.
Corrugado: 120 bolsas.

STS-25

Sacapuntas de plástico traslúcidos. Bolsa con 25 piezas.



Interno: 60 bolsas.
Corrugado: 120 bolsas.



SSN-25

Sacapuntas de plástico colores neón. Bolsa con 25 piezas.



Nuevos



Interno: 60 bolsas.
Corrugado: 120 bolsas.



SSP-25

Sacapuntas de plástico pastel. Bolsa con 25 piezas.



Nuevos



Interno: 60 bolsas.
Corrugado: 120 bolsas.



Sacapuntas

SS2-16

Sacapuntas **doble** de plástico, colores **sólidos** surtidos.
Bolsa con 16 piezas.



Interno: 90 bolsas.
Corrugado: 180 bolsas.



7 502265 161104

SS2-16T

Sacapuntas **doble** de plástico, colores **translúcidos** surtidos.
Bolsa con 16 piezas.



Interno: 90 bolsas.
Corrugado: 180 bolsas.



7 502286 767651

SS2-16N

Sacapuntas **doble** de plástico, colores **neón** surtidos.
Bolsa con 16 piezas.



Interno: 90 bolsas.
Corrugado: 180 bolsas.



7 502286 767668

SS2-16P

Sacapuntas **doble** de plástico, colores **pastel** surtidos.
Bolsa con 16 piezas.

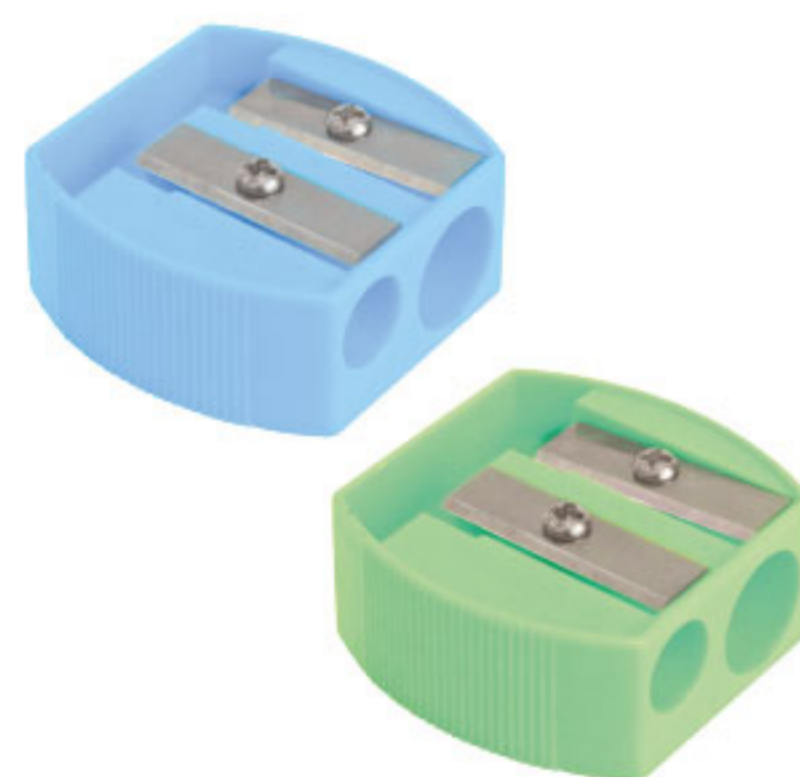

Interno: 90 bolsas.
Corrugado: 180 bolsas.



7 502286 767675

Sacapuntas

SSS-100

Sacapuntas de plástico, colores surtidos.
Bote con 100 piezas.



Interno: 1 bote.
Corrugado: 30 botes.



7 502265 163160

SRB-12BL

Sacapuntas rectangular bicolor. Blíster con 12 piezas.



Interno: 12 blisters.
Corrugado: 360 blisters.



7 502265 161142

SDO-24

Sacapuntas de plástico, forma ovalada, colores surtidos.
Caja con 24 piezas.



Corrugado: 60 cajas.



7 502286 767361

SO2-12P

Sacapuntas de plástico, colores pastel surtidos.
Caja con 12 piezas.



Corrugado: 60 cajas.



7 502286 767804

SDT-24

Sacapuntas de plástico, colores surtidos.
Bote con 24 piezas.



Interno: 1 bote.
Corrugado: 36 botes.



7 502286 767712

SDT-2B

Sacapuntas de plástico, colores surtidos.
Blíster con 2 piezas.



Interno: 12 blisters.
Corrugado: 144 blisters.



7 502286 767729

Sacapuntas

SND-1

Sacapuntas con depósito. Caja con 24 piezas.



Colores:
● ● ● ●



Interno: 24 piezas.
Corrugado: 1 440 piezas.



7 502265 169575

SND-2

Sacapuntas doble con depósito. Caja con 12 piezas.



Colores:
● ● ● ●



Interno: 12 piezas.
Corrugado: 720 piezas.



7 502265 169582

SPD-1CH

Sacapuntas chico con depósito y tapa.
Caja con 36 piezas.



Colores:
● ● ● ● ● ●



Interno: 36 piezas.
Corrugado: 1 080 piezas.



7 502265 169513

SPD-1CH BL4

Sacapuntas chico con depósito y tapa.
Blíster con 4 piezas en colores surtidos.



Corrugado: 56 blisters.



7 502277 581433

SPD-1M

Sacapuntas mediano con depósito y tapa.
Caja con 24 piezas.



Colores:
● ● ● ● ● ●



Interno: 24 piezas.
Corrugado: 720 piezas.



7 502265 169520

SPD-2G

Sacapuntas grande doble con depósito y tapa.
Caja con 24 piezas.



Colores:
● ● ● ● ● ●



Interno: 24 piezas.
Corrugado: 720 piezas.



7 502265 169537

Sacapuntas

SDP-1

Sacapuntas con depósito en forma de pétalo.
Caja con 12 piezas.



Colores:
● ● ● ●



Interno: 12 piezas.
Corrugado: 720 piezas.



7 502265 169605

SDP-2

Sacapuntas doble con depósito en forma de pétalo.
Caja con 12 piezas.



Colores:
● ● ● ●



Interno: 12 piezas.
Corrugado: 720 piezas.



7 502265 169612

SDG-1T

Sacapuntas con depósito y goma. Caja con 24 piezas.



Colores:
● ● ● ●



Interno: 24 piezas.
Corrugado: 1 440 piezas.



7 502265 169551

SDG-2T

Sacapuntas doble con depósito y goma. Caja con 12 piezas.



Colores:
● ● ● ●



Interno: 12 piezas.
Corrugado: 360 piezas.



7 502265 169506

SDG-2TBL

Sacapuntas doble con depósito y goma.
Blíster con 2 piezas en colores surtidos.



Colores:
● ● ● ●



Corrugado: 36 blísters.



7 502277 580856

Sacapuntas

SDR-1

Sacapuntas plástico con depósito. Caja con 24 piezas.



Colores:
● ● ● ●



Interno: 24 piezas.
Corrugado: 1 440 piezas.



7 502277 582362

SDR-2

Sacapuntas plástico doble con depósito. Caja con 12 piezas.



Colores:
● ● ● ●



Interno: 12 piezas.
Corrugado: 360 piezas.



7 502277 582379

SK-48

Sacapuntas con clip integrado. Bote con 48 piezas.



Klipoi

Colores:
● ● ● ●



Interno: 1 bote.
Corrugado: 60 botes.



7 502265 169544

SFP-50

Sacapuntas plástico con formas y colores divertidos. Bote con 50 piezas.



Colores:
● ● ● ●



Interno: 1 bote.
Corrugado: 30 botes.



7 502265 169568

SDC-1

Sacapuntas con depósito en colores brillantes. Bote con 24 piezas.



Interno: 1 bote.
Corrugado: 36 botes.



7 502265 169599

SUJ-32

Sacapuntas de plástico con sujetador, colores surtidos. Caja con 32 piezas.



Nuevos



Interno: 36 piezas.
Corrugado: 60 botes.



7 502286 767743

Sacapuntas

SDK-12

Sacapuntas de plástico, tapa abre/cierra, colores surtidos.
Caja con 12 piezas.



Interno: 12 piezas.
Corrugado: 60 cajas.



7 502286 767767

SDK-2BL

Sacapuntas de plástico, tapa abre/cierra, colores surtidos.
Blíster con 2 piezas.



Interno: 12 blisters.
Corrugado: 96 blisters.



7 502286 767774

SDE-24

Sacapuntas de plástico, forma de esfera, colores surtidos.
Caja con 24 piezas.



Interno: 24 piezas.
Corrugado: 60 cajas.



7 502286 767781

SDH-48

Sacapuntas de plástico en forma de corazón, colores surtidos.
Bote con 48 piezas.



Interno: 48 piezas.
Corrugado: 60 botess.



7 502286 767736

Sacapuntas

SMD-1S

Sacapuntas metálico con depósito.
Caja con 12 piezas.



Colores:
● ● ● ●



Interno: 12 piezas.
Corrugado: 720 piezas.



7 502237 309527

SMD-2S

Sacapuntas metálico doble con depósito.
Caja con 12 piezas.



Colores:
● ● ● ●



Interno: 12 piezas.
Corrugado: 720 piezas.



7 502237 309541

SMD-1T

Sacapuntas metálico con depósito.
Caja con 12 piezas.



Colores:
● ● ● ●



Interno: 12 piezas.
Corrugado: 720 piezas.



7 502237 309480

SMD-2T

Sacapuntas metálico doble con depósito.
Caja con 12 piezas.



Colores:
● ● ● ●



Interno: 12 piezas.
Corrugado: 720 piezas.



7 502237 309503

SMD-1C

Sacapuntas metálico con depósito y tapa.
Caja con 24 piezas.



Colores:
● ● ● ●



Interno: 24 piezas.
Corrugado: 1 440 piezas.



7 502237 309466

SMD-1C BL2

Sacapuntas metálico con depósito y tapa.
Blíster con 2 piezas en colores surtidos.



Colores:
● ● ● ●



Corrugado: 56 blísters.



7 502277 581426

Sacapuntas

SSD2-16

Sacapuntas **doble con depósito**, colores sólidos surtidos. Bolsa con **16** piezas.



Colores:
● ● ● ●



Interno: 90 bolsas.
Corrugado: 180 bolsas.



7 502265 161135

SED-12

Sacapuntas con **depósito** en forma de **estrella**, colores surtidos. Bolsa con **12** piezas.



Colores:
● ● ● ●



Interno: 60 bolsas.
Corrugado: 120 bolsas.



7 502265 161197

SSD-25

Sacapuntas sencillo **con depósito**, colores sólidos surtidos. Bolsa con **25** piezas.



Colores:
● ● ● ●



Interno: 60 bolsas.
Corrugado: 120 bolsas.



7 502265 161111

Tijeras escolares

MT-4

Tijera escolar **punta roma** en funda de PVC.
Hojas de acero **inoxidable** de 4.5" (115 mm).



Colores:
● ● ● ●



Interno: 72 pzas.
Corrugado: 576 pzas.



7 502212 173501

MT-40

Tijera escolar **punta roma** en funda de PVC.
Hojas de acero **inoxidable** de 4.5" (115 mm).



Colores:
● ● ● ●



Interno: 72 pzas.
Corrugado: 576 pzas.



7 502286 767286

MT-5

Tijera escolar **punta roma** en funda de PVC.
Hojas de acero **inoxidable** de 5" (127 mm).



Colores:
● ● ● ●



Interno: 72 pzas.
Corrugado: 576 pzas.



7 502212 171613

MT-50

Tijera escolar **punta roma** en funda de PVC.
Hojas de acero **inoxidable** de 5" (127 mm).



Colores:
● ● ● ●



Interno: 72 pzas.
Corrugado: 576 pzas.



7 502286 767293

MT-5R

Tijera escolar **punta roma** en funda de PVC. Hojas de acero **inoxidable** de 5" (127 mm) con **regla** impresa.



Colores:
● ● ● ●



Interno: 72 pzas.
Corrugado: 576 pzas.



7 502212 170753

MT-5RL

Tijera escolar **punta roma** en funda de PVC. Hojas de acero **inoxidable** de 5" (127 mm) con **regla** impresa.



Colores:
● ● ● ●



Interno: 72 pzas.
Corrugado: 576 pzas.



7 502212 171576

Tijeras escolares

MT-5T

Tijera escolar **punta roma** en blíster. Hojas de acero **inoxidable** de 5" (127 mm).



Colores:
● ● ● ●



Interno: 12 pzas.
Corrugado: 360 pzas.

MT-5M

Tijera escolar **punta roma** en blíster. Hojas de acero **inoxidable** de 5" (127 mm).



Colores:
● ● ● ●



Interno: 12 pzas.
Corrugado: 360 pzas.

MT-5G

Tijera escolar **punta roma** en blíster. Hojas de acero **inoxidable** de 5" (127 mm) con **grip**.



Colores:
● ● ● ●



Interno: 12 pzas.
Corrugado: 360 pzas.

Tijeras de oficina

MT-6

Tijera para oficina en funda de PVC.
Hojas de acero inoxidable de 6" (152 mm).



Colores:



Interno: 12 pzas.
Corrugado: 240 pzas.



7 502212 171620

MT-6G

Tijera para oficina con grip en Blíster.
Hojas de acero inoxidable de 6" (152 mm).



Colores:



Interno: 12 pzas.
Corrugado: 288 pzas.



7 502286 766098

MT-7

Tijera para oficina en funda de PVC.
Hojas de acero inoxidable de 7" (178 mm).



Colores:



Interno: 12 pzas.
Corrugado: 240 pzas.



7 502212 172658

MT-7G

Tijera para oficina con grip en blíster.
Hojas de acero inoxidable de 7" (178 mm).



Colores:



Interno: 12 pzas.
Corrugado: 240 pzas.



7 502286 766081

MT-8

Tijera para oficina en funda de PVC.
Hojas de acero inoxidable de 8" (203 mm).



Colores:



Interno: 12 pzas.
Corrugado: 240 pzas.



7 502212 171637

MT-8G

Tijera para oficina con grip en blíster.
Hojas de acero inoxidable de 8" (203 mm).



Colores:



Interno: 12 pzas.
Corrugado: 144 pzas.



7 502286 766074

Tijeras

TAF-6

Tijera de **acero** en Blíster.
Hojas de acero **inoxidable** de 6" (152 mm).



Interno: 12 pzas.
Corrugado: 240 pzas.



7 502286 766067

TAF-7

Tijera de **acero** en blíster.
Hojas de acero **inoxidable** de 7" (178 mm).



Interno: 12 pzas.
Corrugado: 144 pzas.



7 502286 766050

TAF-8

Tijera de **acero** en blíster.
Hojas de acero **inoxidable** de 8" (203 mm).



Interno: 12 pzas.
Corrugado: 144 pzas.



7 502286 766043

RT-7B

Tijera **RAZOR** de 8" (203 mm). Hojas de acero **inoxidable**,
mango suave. Ideal para hogar, oficina y costura.



Interno: 12 blisters.
Corrugado: 72 blisters.



7 502237 303747

Calculadoras

MC-1000

Calculadora escolar de 8 dígitos.



Características:

- Apagado automático.
- Dual: pilas y solar.
- % porcentaje.
- 8 dígitos.
- Memoria.



Interno: 24 pzas.
Corrugado: 360 pzas.



7 502265 166611

MCC-56

Calculadora científica de 56 funciones.

Características:

- Operaciones de 10 dígitos de funciones científicas y estadísticas.
- Cubierta dura para protección contra el polvo y golpes.
- 56 funciones científicas básicas y avanzadas.
- Seis operaciones básicas y cálculo de memoria.
- Cuatro operaciones con números complejos.
- Cálculos estadísticos.
- Cálculo binario, octal, decimal y número hexadecimal.
- Conversor de unidades.
- Incluye instructivo.
- Apagado automático.

Características eléctricas:

- Utiliza 1 pila tipo botón "AG10" (1x1.5Vcc) 1.5 Vcc



Interno: 24 pzas.
Corrugado: 240 pzas.



7 502265 166604

CINTAS Y ADHESIVOS

Lápices adhesivos

LAM-924

Lápiz adhesivo de 9 g, caja con 24 piezas.



Caja con 24 pzas.



Interno: 1 caja.
Corrugado: 16 cajas.



7 502237 301521

LAM-924 B4

Lápiz adhesivo de 9 g, bolsa con 2 piezas.



Corrugado: 72 piezas.



7 502277 581549

LAM-2024

Lápiz adhesivo de 20 g, caja con 24 piezas.



Caja con 24 pzas.



Interno: 1 caja.
Corrugado: 16 cajas.



7 502237 301545

LAM-406

Lápiz adhesivo de 40 g, caja con 6 piezas.



Caja con 6 pzas.



Interno: 1 caja.
Corrugado: 36 cajas.



7 502237 308995

Adhesivos y mica

LAM-4AF

Lápiz adhesivo de 8 g, con aroma frutal.
Caja con 4 piezas.



Interno: 12 cajas.
Corrugado: 72 cajas.



7 502286 767170

PLT-45BL2

Pegamento líquido transparente de 45 g
doble punta, fina y gruesa. Blíster con 2 piezas.



DOBLE
PUNTA



Interno: 12 blísters.
Corrugado: 72 blísters.



7 502286 767156

MPVC

Mica autoadhesiva multiusos, calibre 5. Medida de 50 x 66 cm. Bolsa con presentación de 10, 50 y 100 piezas.

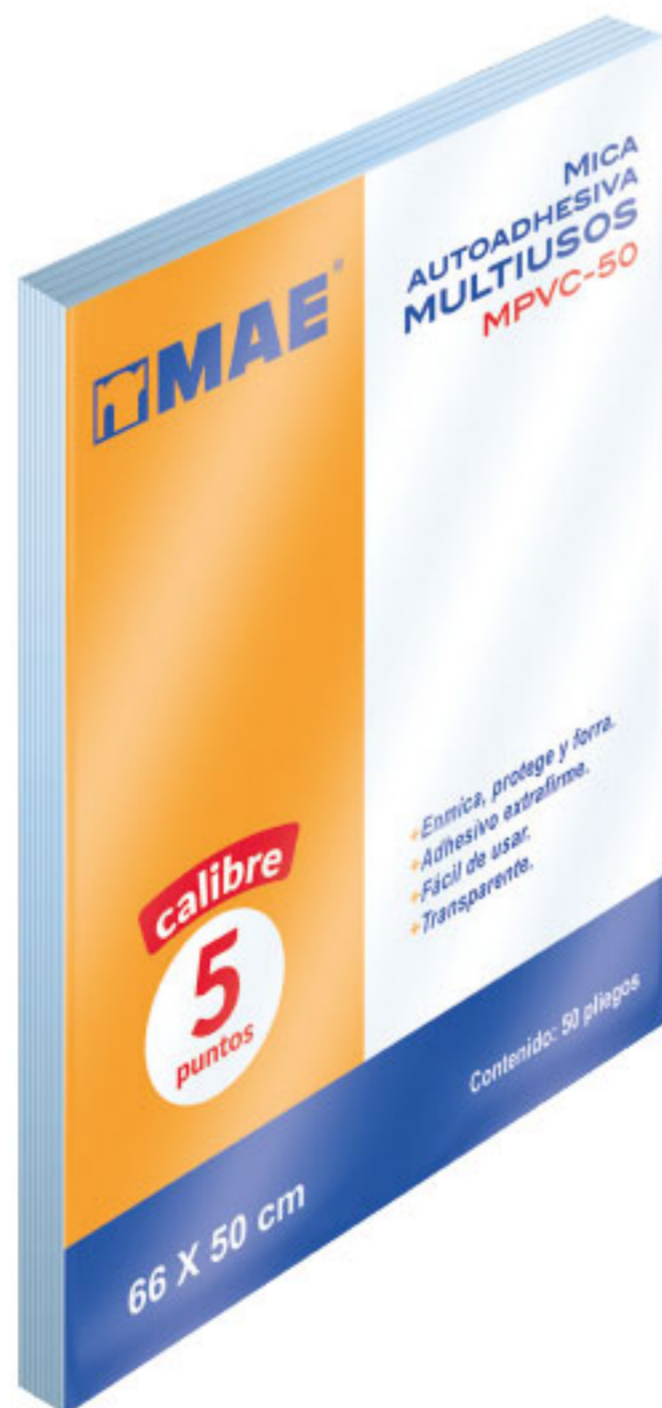

MPVC-10



7 502265 163702



Corrugado: 30 bolsas.

MPVC-50



7 502286 765190



Corrugado: 6 bolsas.

MPVC-100



7 502265 163719



Corrugado: 3 bolsas.

Cintas

BC

Cinta cristal.



BC-10: 12 mm x 10 m.
bolsa con 36 piezas.
BC-22: 12 mm x 33 m.
BC-42: 18 mm x 33 m.



BC-24: 12 mm x 65 m.
BC-46: 18 mm x 65 m.
BC-50: 24 mm x 65 m.



Interno: 1 bolsa.
Corrugado: 16 bolsas.



Interno: 8 pzas.
Corrugado: 480 pzas.



Interno: 16 pzas.
Corrugado: 288 pzas.



Interno: 8 pzas.
Corrugado: 144 pzas.



CI-10

Cinta invisible de 19 mm x 33 m.



Interno: 1 pza.
Corrugado: 288 pzas.



CI-40

Cinta invisible de 24 mm x 65 m.



Interno: 1 pza.
Corrugado: 144 pzas.



Cintas

TI-06

Cinta invisible de 18 mm x 19 m, tubo con 6 piezas.



Interno: 10 tubos.
Corrugado: 60 tubos.



7 502212 170562

TC-10

Cinta cristal de 18 mm x 19 m, tubo con 10 piezas.



Interno: 10 tubos.
Corrugado: 60 tubos.



7 502212 170593

TI-10

Cinta invisible de 18 mm x 19 m, tubo con 10 piezas.



Interno: 10 tubos.
Corrugado: 60 tubos.



7 502212 170579

CE-10

Cinta cristal para empaque. Medida: 48 mm x 50 m.



Interno: 1 pza.
Corrugado: 96 pzas.



7 502212 170609

PCT-1215/12

Tubo con 12 cintas transparentes. Medidas: 12 mm x 14.6 m.



Interno: 1 tubo.
Corrugado: 45 tubos.



7 754005 380591

Cintas

MC-4850C

Cinta para empaque color canela.
Medidas: 48 mm x 50 m. Paquete con 6 piezas.



Interno: 1 paquete.
Corrugado: 6 paquetes.



7 502265 168943

MC-4850T

Cinta para empaque transparente.
Medidas: 48 mm x 50 m. Paquete con 6 piezas.



Interno: 1 paquete.
Corrugado: 6 paquetes.



7 502265 168967

MC-4815C

Cinta para empaque color canela.
Medidas: 48 mm x 150 m. Paquete con 6 piezas.



Interno: 1 paquete.
Corrugado: 4 paquetes.



7 502265 168950

MC-4815T

Cinta para empaque transparente.
Medidas: 48 mm x 150 m. Paquete con 6 piezas.



Interno: 1 paquete.
Corrugado: 4 paquetes.



7 502265 168974

Cintas

MCT-1233

Cinta adhesiva transparente **fácil de cortar.**
Medida: 12 mm x 33 m.



Interno: 12 pzas.
Corrugado: 180 pzas.

**MCT-1265**

Cinta adhesiva transparente **fácil de cortar.**
Medida: 12 mm x 66 m.



Interno: 12 pzas.
Corrugado: 72 pzas.

**MCT-1833**

Cinta adhesiva transparente **fácil de cortar.**
Medida: 18 mm x 33 m.



Interno: 8 pzas.
Corrugado: 120 pzas.

**MCT-1865**

Cinta adhesiva transparente **fácil de cortar.**
Medida: 18 mm x 66 m.



Interno: 8 pzas.
Corrugado: 48 pzas.



Cintas

MCT-2465

Cinta adhesiva transparente **fácil de cortar**.
Medida: 24 mm x 66 m.



Interno: 6 pzas.
Corrugado: 36 pzas.



7 502277 589880

MCI-10

Cinta **invisible**, hecha de acetato de celulosa. Medidas: 19 mm x 33 m.



Interno: 1 pieza.
Corrugado: 288 pzas.



7 502277 589897

MCT-1210/50

Cinta adhesiva transparente **fácil de cortar**. Medida: 12 mm x 10 m, bolsa con 50 piezas.



Corrugado: 5 bolsas.



Bolsa de 50 piezas.
7 502277 589910

Película protectora transparente

3510T

Película protectora autoadherible transparente. Rollo de 35 cm x 10 m.



Interno: 1 rollo.
Corrugado: 40 rollos.



7 502286 762847

4502T

Película protectora autoadherible transparente. Rollo de 45 cm x 2 m.



Interno: 1 rollo.
Corrugado: 60 rollos.



7 502212 174652

4505T

Película protectora autoadherible transparente. Rollo de 45 cm x 5 m.



Interno: 1 rollo.
Corrugado: 40 rollos.



7 502237 303860

4510T

Película protectora autoadherible transparente. Rollo de 45 cm x 10 m.



Interno: 1 rollo.
Corrugado: 20 rollos.



7 502212 179800

4520T

Película protectora autoadherible transparente. Rollo de 45 cm x 20 m.



Interno: 1 rollo.
Corrugado: 12 rollos.



7 502212 174645

Película protectora de colores

4510

Película protectora autoadherible de 45 cm x 10 m en **colores**: morado, azul, celeste, verde, verde claro, naranja, naranja fluorescente, amarillo, rojo, rosa, rosa claro, café, negro y blanco.

4510MO



4510A



 Interno: 1 rollo.
Corrugado: 20 rollos.

4510CE



4510R



4510VE



4510RS



4510VC



4510RSC



4510NA



4510CA



4510NAF



4510N



4510AM



4510B



4510MO



7 502237 303662

4510A



7 502237 301651

4510CE



7 502237 301682

4510VE



7 502237 301668

4510VC



7 502265 163115

4510NA



7 502237 303686

4510NAF



7 502265 163092

4510AM



7 502237 301675

4510R



7 502237 301644

4510RS



7 502237 303655

4510RSC



7 502265 163108

4510CA



7 502265 163122

4510N



7 502265 163139

4510B



7 502237 303679

Película protectora de colores

45015

45015MO



45015A



45015CE



45015VE



45015VC



45015NA



45015NAF



45015AM



Película protectora autoadherible de **45 cm x 1.5 m** en **colores**: morado, azul, celeste, verde, verde claro, naranja, naranja fluorescente, amarillo, rojo, rosa, rosa claro, café, negro y blanco.



Interno: 1 rollo.
Corrugado: 60 rollos.

45015R



45015RS



45015RSC



45015CA



45015N



45015B



45015MO



7 502265 165775

45015A



7 502265 165720

45015CE



7 502265 165751

45015VE



7 502265 165850

45015VC



7 502265 165843

45015NA



7 502265 165799

45015NAF



7 502265 165805

45015AM



7 502265 165768

45015R



7 502265 165812

45015RS



7 502265 165829

45015RSC



7 502265 165836

45015CA



7 502265 165737

45015N



7 502265 165782

45015B



7 502265 165744

Película decorativa diamantada

PD4503

PD4503-AM



PD4503-DO



PD4503-OC



PD4503-C



PD4503-RJ



PD4503-RJO



PD4503-RS



PD4503-RSC



PD4503-MG



PD4503-LI



PD4503-MO



PD4503-AR



Película decorativa autoadherible de 45 cm x 3 m **diamantada**: amarillo, aqua, azul rey, azul, café, dorado, gris, lila, magenta, morado, negro, oro claro, plata, rojo, rojo oscuro, rosa, rosa claro, turquesa, verde y verde limón.



Interno: 1 rollo.
Corrugado: 24 rollos.

PD4503-AZ



PD4503-TQ



PD4503-AQ



PD4503-VL



PD4503-VE



PD4503-G



PD4503-NE

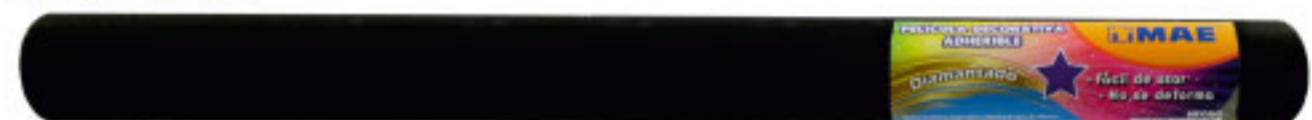

PD4503-PL



PD4503-AM	7502286762885	PD4503-RJO	7502286764001	PD4503-MO	7502286762908	PD4503-VL	7502286762953
PD4503-DO	7502286762861	PD4503-RS	7502286762922	PD4503-AR	7502286762984	PD4503-VE	7502286762960
PD4503-OC	7502286762878	PD4503-RSC	7502286762991	PD4503-AZ	7502286762977	PD4503-G	7502286763028
PD4503-C	7502286763011	PD4503-MG	7502286762915	PD4503-TQ	7502286762946	PD4503-NE	7502286763035
PD4503-RJ	7502286763004	PD4503-LI	7502286762892	PD4503-AQ	7502286762939	PD4503-PL	7502286762854

Sujetadocumentos

BC-15

Sujetadocumentos de 15 mm ($\frac{1}{2}$ "), con capacidad para 30 hojas. Caja con 12 piezas.



Interno: 12 cajas.
Corrugado: 480 cajas.



7 502237 305666

BC-19

Sujetadocumentos de 19 mm ($\frac{3}{4}$ "), con capacidad para 40 hojas. Caja con 12 piezas.



Interno: 12 cajas.
Corrugado: 432 cajas.



7 502212 170050

BC-25

Sujetadocumentos de 25 mm (1"), con capacidad para 60 hojas. Caja con 12 piezas.



Interno: 12 cajas.
Corrugado: 240 cajas.



7 502212 170067

BC-32

Sujetadocumentos de 32 mm ($1\frac{1}{4}$ "), con capacidad para 80 hojas. Caja con 12 piezas.



Interno: 12 cajas.
Corrugado: 144 cajas.



7 502212 170074

BC-41

Sujetadocumentos de 41 mm ($1\frac{5}{8}$ "), con capacidad para 90 hojas. Caja con 12 piezas.



Interno: 1 caja.
Corrugado: 72 cajas.



7 502212 170081

BC-51

Sujetadocumentos de 51 mm (2"), con capacidad para 110 hojas. Caja con 12 piezas.



Interno: 1 caja.
Corrugado: 48 cajas.



7 502212 170098

Clips

CM1 / CM2

Clip mariposa niquelado



CM1:
#1 de 4.5 x 6.6 cm, paquete con 12 cajas de 12 piezas c/u.
CM2:
#2 de 3.2 x 4.1 cm, paquete con 10 cajas de 50 piezas c/u.

CM1

Paquete con 12 cajas.



7 502212 171835



Interno: 1 paquete.
Corrugado: 12 paquetes.

CM2

Paquete con 10 cajas.



7 502212 171842



Interno: 1 paquete.
Corrugado: 10 paquetes.

CC1 / CC2

Clip rectangular niquelado



CC1:
#1 de 33 mm, paquete con 10 cajas de 100 piezas c/u.
CC2:
#2 de 28 mm, paquete con 10 cajas de 100 piezas c/u.

CC1

Paquete con 10 cajas.



7 502212 171774



Interno: 1 paquete.
Corrugado: 30 paquetes.

CC2

Paquete con 10 cajas.



7 502212 171781

CS1 / CS2 / CS3

Clip estándar niquelado

CS1: #1 de 33 mm
CS2: #2 de 28 mm
CS3: #3 de 24 mm

Paquete de 10 cajas con 100 piezas c/u.



CS1

Paquete con 10 cajas.



7 502212 171798



Interno: 1 paquete.
Corrugado: 30 paquetes.

CS2

Paquete con 10 cajas.



7 502212 171804

CS3

Paquete con 10 cajas.



7 502212 171811

CSJ

Clip estándar jumbo niquelado de 50 mm, paquete de 10 cajas con 100 piezas c/u.



Paquete con 10 cajas.



7 502212 171828



Interno: 1 paquete.
Corrugado: 10 paquetes.

CSC-2B

Clip estándar #2 de 28 mm, vinílicos de colores, blíster con 100 piezas.



Interno: 24 blisters.
Corrugado: 288 blisters.



7 502212 172269

Broches

BR-70

Broche metálico de 7 cm de distancia entre orificios.
Caja con 50 juegos.



Interno: 10 cajas.
Corrugado: 80 cajas.



7 502212 170005

BR-80

Broche metálico de 8 cm de distancia entre orificios.
Caja con 50 juegos.



Interno: 20 cajas.
Corrugado: 80 cajas.



7 502212 170012

BRL

Broche latonado. Caja con 100 piezas.

BRL-31
31 mm



BRL-25
25 mm



BRL-19
19 mm



BRL-14
14 mm



Interno: 10 cajas.
Corrugado: 250 cajas.



7 502212 177721



Interno: 10 cajas.
Corrugado: 300 cajas.



7 502212 177714



7 502212 177707



7 502212 177691

Tachuelas y pines

TLC

Tachuela latonada, caja con 100 piezas.



Interno: 12 cajas.
Corrugado: 576 cajas.



7 502212 178483

TNC

Tachuela niquelada, caja con 100 piezas.



Interno: 12 cajas.
Corrugado: 576 cajas.



7 502212 178476

TCC

Tachuelas de colores con cubierta de PVC, caja con 100 piezas.

TCC-NG



TCC-AZM



TCC-RJ



TCC-VE



TCC-AM



TCC-BL



TCC



Interno: 12 cajas.
Corrugado: 576 cajas.

TCC-NG



7 502237 300418

TCC-AZM



7 502237 300425

TCC-RJ



7 502237 300432

TCC-VE



7 502237 300449

TCC-AM



7 502237 300456

TCC-BL



7 502237 300463

TCC



7 502212 178490

PP-100



PP-100



7 502212 176663

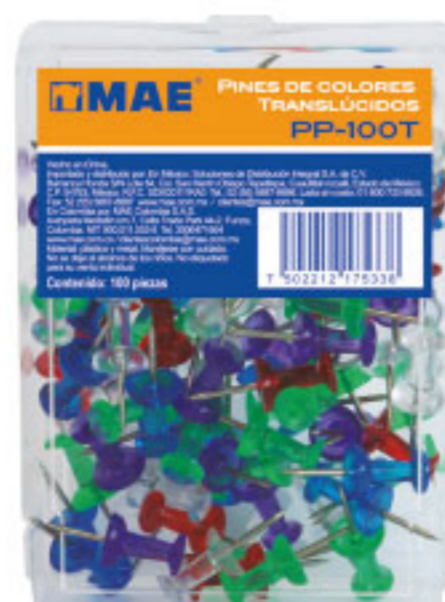

PP-100T



7 502212 175338



PP-100BT



7 502237 300401

PP-100
Pines de colores sólidos.
PP-100T
Pines de colores
traslúcidos.
PP-100BT
Pines transparentes.

Cajas con 100 piezas.



Interno: 12 cajas.
Corrugado: 240 cajas.

Protectores de hojas

PH-100

Protectores de hojas tamaño **carta**, caja con **100** piezas.



Interno: 1 caja.
Corrugado: 20 cajas.



7 502212 170760

PHO-100

Protectores de hojas tamaño **oficio**, caja con **100** piezas.



Interno: 1 caja.
Corrugado: 20 cajas.



7 502212 176694

PH-100A

Protectores de hojas **antirreflejantes** tamaño **carta**, caja con **100** piezas.



Interno: 1 caja.
Corrugado: 20 cajas.



7 502212 171651

PH-100AG

Protectores de hojas **antirreflejantes gruesos** tamaño **carta**, caja con **100** piezas.



Interno: 1 caja.
Corrugado: 20 cajas.



7 502212 171569

PH-100B

Protectores de hojas tamaño **carta**, bolsa con **100** piezas.



Interno: 1 bolsa.
Corrugado: 20 bolsas.



7 502237 301507

PH-20B

Protectores de hojas tamaño **carta**, bolsa con **20** piezas.



Interno: 1 bolsa.
Corrugado: 50 bolsas.



7 502277 585134

ACCESORIOS DE ESCRITURA

Gomas

G-ALIM

Gomas para borrar con forma de alimentos.
Cartulina con 35 piezas.

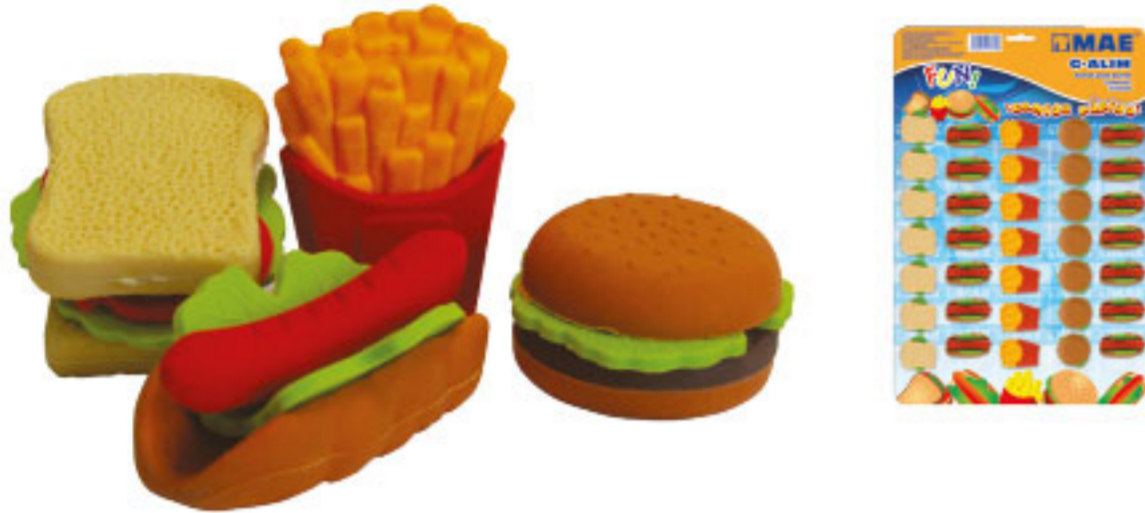

Interno: 1 blíster.
Corrugado: 36 blisters.



7 502212 175703

GALI-5B

Gomas para borrar con forma de alimentos.
Blíster con 5 piezas.



Corrugado: 56 blisters.



7 502265 164846

G-MANIM

Gomas para borrar con forma de animales.
Cartulina con 35 piezas.



Interno: 1 blíster.
Corrugado: 36 blisters.



7 502237 307141

GMANI-5B

Gomas para borrar con forma de animales.
Blíster con 5 piezas.



Corrugado: 56 blisters.



7 502277 581402

G-KIDS

Gomas para borrar con forma de balones y herramientas.
Cartulina con 35 piezas.



Interno: 1 blíster.
Corrugado: 36 blisters.



7 502265 164327

GKIDS-5B

Gomas para borrar con forma de balones y herramientas.
Blíster con 5 piezas.



Corrugado: 56 blisters.



7 502277 581372

Gomas

G-FASHION

Gomas para borrar con forma de accesorios.
Cartulina con 35 piezas.



Interno: 1 blíster.
Corrugado: 36 blisters.



7 502277 586964

GFASH-5B

Gomas para borrar con forma de accesorios.
Blíster con 5 piezas.



Corrugado: 56 blisters.



7 502277 587190

G-SWEET

Gomas para borrar con forma de dulces.
Cartulina con 35 piezas.



Interno: 1 blíster.
Corrugado: 36 blisters.



7 502277 586940

GSWEET-5B

Gomas para borrar con forma de dulces.
Blíster con 5 piezas.



Corrugado: 56 blisters.



7 502277 587206

G-CACTUS

Gomas para borrar con forma de cactus.
Cartulina con 35 piezas.



Interno: 1 blíster.
Corrugado: 36 blisters.



7 502277 586988

GCACTUS-5B

Gomas para borrar con forma de cactus.
Blíster con 5 piezas.



Corrugado: 56 blisters.



7 502277 587213

Gomas

G-POST

Gomas para borrar con forma de postres.
Cartulina con 35 piezas.



Interno: 1 blíster.
Corrugado: 36 blísters.



7 502212 175734

GPOS-5B

Gomas para borrar con forma de postres.
Blíster con 5 piezas.



Corrugado: 56 blísters.



7 502265 164839

G-ZOO

Gomas para borrar con forma de animales.
Cartulina con 35 piezas.



Interno: 1 blíster.
Corrugado: 36 blísters.



7 502265 162828

GZOO-5B

Gomas para borrar con forma de animales.
Blíster con 5 piezas.



Corrugado: 56 blísters.



7 502265 164822

G-BABY

Gomas para borrar con forma de animales.
Cartulina con 35 piezas.



Interno: 1 blíster.
Corrugado: 36 blísters.



7 502265 164341

GBABY-5B

Gomas para borrar con forma de animales.
Blíster con 5 piezas.



Corrugado: 56 blísters.



7 502277 581365

Gomas

G-MUSIC

Gomas para borrar con forma de instrumentos musicales.
Cartulina con 35 piezas.



Nuevos



Interno: 1 blíster.
Corrugado: 36 blísters.



7 502286 766906

GMUSIC-5B

Gomas para borrar con forma de instrumentos musicales.
Blíster con 5 piezas.



Nuevos



Corrugado: 56 blísters.



7 502286 766913

G-BUGS

Gomas para borrar con forma de insectos.
Cartulina con 35 piezas.



Nuevos



Interno: 1 blíster.
Corrugado: 36 blísters.



7 502286 766968

GBUGS-5B

Gomas para borrar con forma de insectos.
Blíster con 5 piezas.



Nuevos



Corrugado: 56 blísters.



7 502286 766975

G-SPACE

Gomas para borrar con forma del espacio.
Cartulina con 35 piezas.



Nuevos



Interno: 1 blíster.
Corrugado: 36 blísters.



7 502286 766937

GSPACE-4B

Gomas para borrar con forma del espacio.
Blíster con 5 piezas.



Nuevos



Corrugado: 56 blísters.



7 502286 766944

Gomas

GM-20MJ

Goma para borrar tipo migajón, ideal para dibujantes, extra suave. Caja con 20 piezas.



Interno: 1 caja.
Corrugado: 40 cajas.



7 502237 301439

GM-30BE

Goma blanca para borrar. Caja con 30 piezas.



Interno: 1 caja.
Corrugado: 30 cajas.



7 502237 301453

GM-60BE

Goma blanca para borrar. Caja con 60 piezas.



Interno: 1 caja.
Corrugado: 40 cajas.



7 502237 301460

GM-40MJ

Goma para borrar tipo migajón, ideal para dibujantes, extra suave. Caja con 40 piezas.



Interno: 1 caja.
Corrugado: 30 cajas.



7 502237 301446

GM-30BE BL6

Goma blanca. Blíster con 6 piezas.

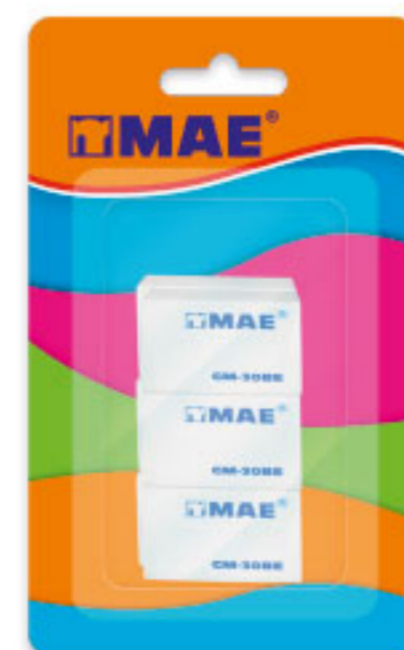

Corrugado: 56 blísters.



7 502277 581396

Gomas

GM-B40

Goma **bicolor** para borrar grafito y tinta.
Caja con 40 piezas.



Interno: 1 caja.
Corrugado: 40 cajas.



7 502237 304805

GM-B80

Goma **bicolor** para borrar grafito y tinta.
Caja con 80 piezas.



Interno: 1 caja.
Corrugado: 40 cajas.



7 502237 304812

GM-20PM

Goma **suave** para borrar **SKIPRO**, ideal para dibujantes.
Caja con 20 piezas.



Interno: 1 caja.
Corrugado: 30 cajas.



7 502237 301477

GM-20PM BL3

Goma **suave**. Bolsa con 3 piezas.



Corrugado: 56 blisters.



7 502277 581020

GB4-NAV

Blíster con 4 gomas de figuras **navideñas** para borrar.



Interno: 1 blíster.
Corrugado: 192 blisters.



7 502265 164365

GMNP-3B

Goma **suave** para borrar **PREMIUM**, ideal para dibujantes.
Bolsa con 3 piezas.



Interno: 1 caja.
Corrugado: 30 cajas.



7 502286 767231

Gomas

GL-25

Gomas de capuchón para lápiz estándar en colores neón. Bolsa con 25 piezas.



Interno: 24 bolsas.
Corrugado: 144 bolsas.



7 502265 169810

GL-100

Gomas de capuchón para lápiz estándar en colores neón. Bolsa con 100 piezas.



Interno: 6 bolsas.
Corrugado: 72 bolsas.



7 502265 169827

GB-TRILAP4

Gomas de borrar triangulares para lápiz. Ayuda a sostener el lápiz de manera más cómoda. Bolsa con 4 piezas.



Interno: 60 bolsas.
Corrugado: 360 bolsas.



7 502237 301514

GB-TLN4

Gomas de borrar triangulares para lápiz en colores neón. Ayuda a sostener el lápiz de manera más cómoda. Bolsa con 4 piezas.



Interno: 60 bolsas.
Corrugado: 360 bolsas.



7 502265 169674

Entrenador y correctores

ELE-4BL

Entrenador para **escritura**, ayuda a una **correcta postura**. Blíster con cuatro entrenadores en colores **surtidos**.



Interno: 24 blisters.
Corrugado: 288 blisters.



7 502286 765367

COC-56

Corrector en cinta **retráctil**. Cinta de 5 mm x 6 m.



Interno: 12 pzas.
Corrugado: 288 pzas.



7 502237 306762

CCT-6

Corrector **en cinta** de 5 mm x 6 m.



Interno: 1 caja c/12 pzas.
Corrugado: 288 pzas.



7 502265 163481

Correctores

CPM-128

Corrector tipo pluma de 8 ml y punta de 0.8 mm, máxima limpieza y precisión. Caja exhibidora con 12 piezas.



Caja con 12 piezas.



Interno: 1 caja.
Corrugado: 48 cajas.



7 502237 303891

CPM-8BL

Corrector tipo pluma de 8 ml. Blíster con 1 pieza.



Interno: 12 blisters.
Corrugado: 288 blisters.



7 502277 581518

CBM-2012

Corrector líquido en bote de 20 ml, secado rápido y no se transparenta. Caja exhibidora con 12 piezas.



Caja con 12 piezas.



Interno: 1 caja.
Corrugado: 48 cajas.



7 502277 581457

CDM-1512

Corrector líquido 2 en 1 de 15 ml, con brocha y pluma, secado rápido y no se transparenta. Caja exhibidora con 12 piezas.



Interno: 1 caja.
Corrugado: 48 cajas.



Caja con 12 piezas.
7 502277 581501

Lápices

LM-72

Lápiz de grafito **triangulares**, mina del No. 2.
Bote con **72** piezas c/u.



Interno: 2 botes con 72 pzas c/u.
Corrugado: 16 botes.



LM-12

Lápiz de grafito **triangulares**, mina del No. 2.
Caja con **12** piezas.



Interno: 1 caja con 12 piezas.
Corrugado: 240 cajas.



LM-12NBL

Lápiz de grafito **triangular**, mina del No. 2.
Blíster con **12** lapices neón.



Interno: 1 blísters.
Corrugado: 144 blísters.



LM-72 BL8

Lápiz de grafito **triangular**, mina del No. 2.
Bolsa con **8** piezas.

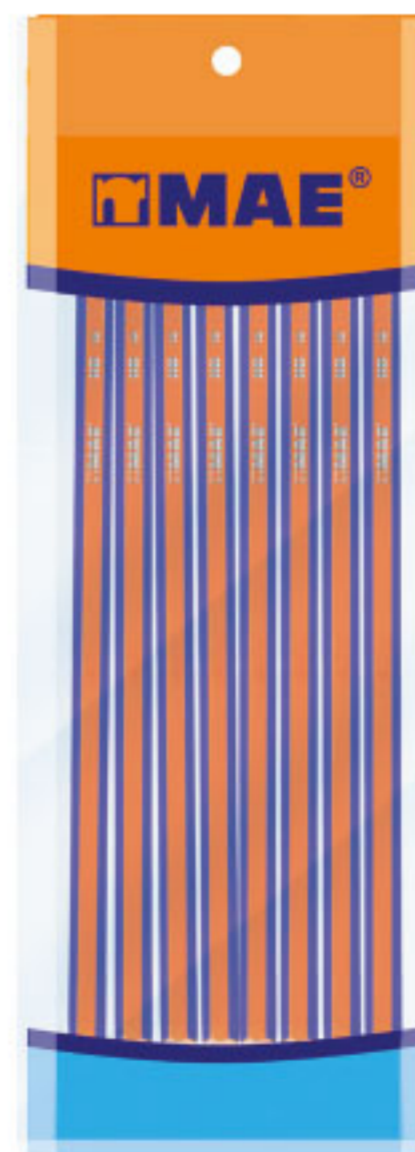

Corrugado: 108 bolsas.



Lápiz de dibujo

LD

Lápiz de grafito hexagonal para dibujo, mina H6, H5, H4, H3, H2, H, HB, B, B2, B3, B4, B5, B6.
Caja con 12 piezas c/u.



LD-5H 7 502286 765794	LD-4H 7 502286 765800	LD-3H 7 502286 765817	LD-2H 7 502286 765824	LD-H 7 502286 765831	LD-HB 7 502286 765848
LD-B 7 502286 765855	LD-2B 7 502286 765862	LD-3B 7 502286 765879	LD-4B 7 502286 765886	LD-5B 7 502286 765893	LD-6B 7 502286 765909



Interno: 12 cajas.
Corrugado: 240 cajas.

LD-12E

Lápiz de grafito hexagonal para dibujo en estuche, con minas H4, H3, H2, H, F, HB, B, B2, B3, B4, B5, B6.
Estuche con 12 piezas diferentes c/u.

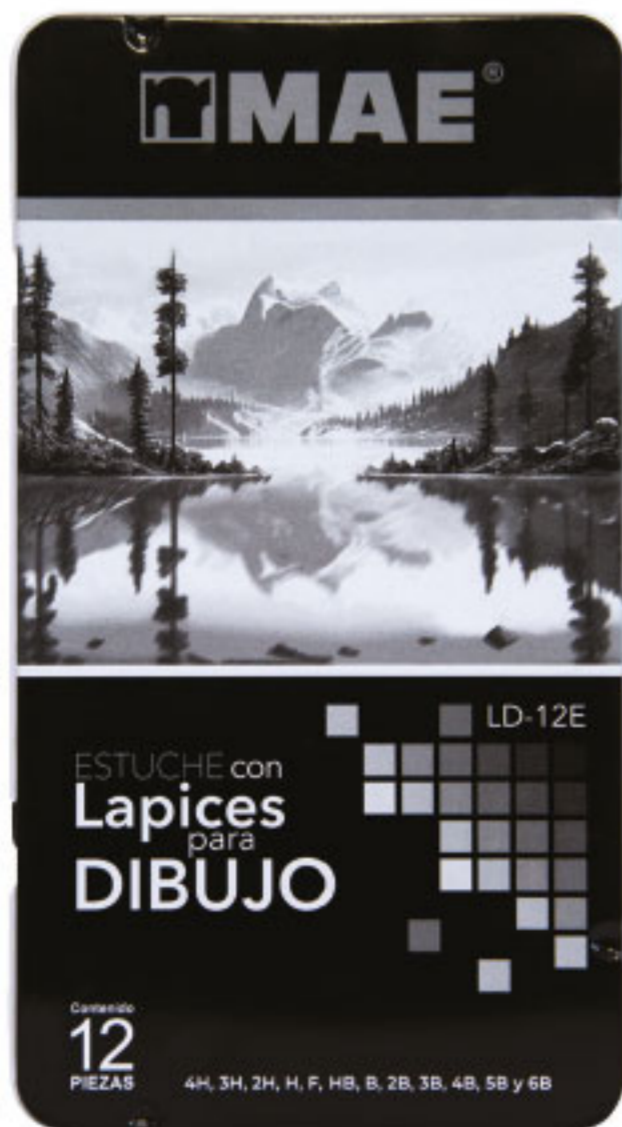

Interno: 12 sets.
Corrugado: 120 sets.



Colores PREMIUM

CRP-12L

Lápices de colores PREMIUM largos, mina de 4 mm.
Caja con 12 piezas.

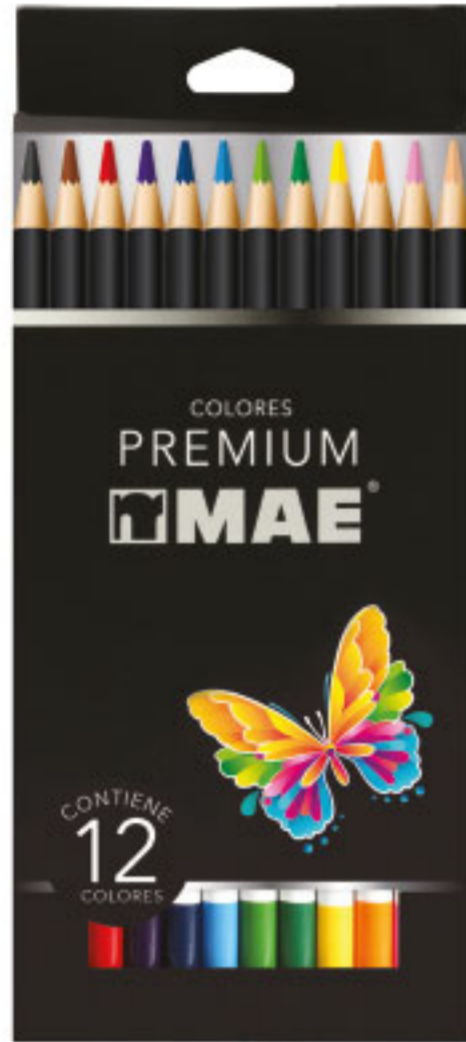

Interno: 12 cajas.
Corrugado: 240 cajas.



7 502286 765305

CRP-24L

Lápices de colores PREMIUM largos, mina de 4 mm.
Caja con 24 piezas.



Interno: 6 cajas.
Corrugado: 120 cajas.



7 502286 765312

CRP-36L

Lápices de colores PREMIUM largos, mina de 4 mm.
Caja con 36 piezas.



Interno: 4 cajas.
Corrugado: 80 cajas.



7 502286 765329

CRP-48L

Lápices de colores PREMIUM largos, mina de 4 mm.
Caja con 48 piezas.



Interno: 3 cajas.
Corrugado: 60 cajas.



7 502286 765336

Colores

CM-12L

Lápices de colores largos, mina de 4 mm.
Caja con 12 piezas y 1 sacapuntas.



Interno: 6 cajas.
Corrugado: 288 cajas.



7 502237 304515

CM-24L

Lápices de colores largos, mina de 4 mm.
Caja con 24 piezas y 1 sacapuntas..



Interno: 3 cajas.
Corrugado: 144 cajas.



7 502237 304522

CM-36L

Lápices de colores largos, mina de 4 mm.
Caja con 36 piezas y 1 sacapuntas.



Interno: 4 cajas.
Corrugado: 72 cajas.



7 502237 306915

CMP-12L

Lápices de colores pastel largos, mina de 4 mm.
Caja con 12 piezas.



Interno: 12 cajas.
Corrugado: 144 cajas.



7 502286 763707

Colores

CMT-12L

Lápices de colores **triangulares** largos, no tóxicos, mina de 4 mm. Caja con 12 piezas y 1 sacapuntas.



Interno: 6 cajas.
Corrugado: 288 cajas.



7 502265 168837

CMT-24L

Lápices de colores **triangulares** largos, no tóxicos, mina de 4 mm. Caja con 24 piezas y 1 sacapuntas.



Interno: 3 cajas.
Corrugado: 144 cajas.



7 502265 168844

CMT-36L

Lápices de colores **triangulares** largos, no tóxicos, mina de 4 mm. Caja con 36 piezas y 1 sacapuntas.



Interno: 4 cajas.
Corrugado: 72 cajas.



7 502265 168851

CMJ-12T

Lápices de colores **triangulares jumbo**, no tóxicos, mina de 5 mm. Caja con 12 piezas.



JUMBO



Interno: 3 cajas.
Corrugado: 144 cajas.



7 502265 168868

Bicolor y Dúo

CM-12B

Lápices de colores largos de **doble punta**, no tóxicos.
12 bicolores = 24 colores. Caja con 12 piezas.



Interno: 12 cajas.
Corrugado: 144 cajas.



7 502237 309824

CM-18B

Lápices de colores largos de **doble punta**, no tóxicos.
18 bicolores = 36 colores. Caja con 18 piezas.



Interno: 8 cajas.
Corrugado: 96 cajas.



7 502237 309831

CM-12C

Lápices de colores **cortos**, no tóxicos. Caja con 12 piezas.



Interno: 12 cajas.
Corrugado: 480 cajas.



7 502237 309817

DT-10

Lápiz **dúo** grafito y rojo carmín, **mina resistente**. Caja con 10 piezas.



Interno: 12 cajas.
Corrugado: 192 cajas.



7 502265 163528

DT-10/4B

Lápiz **dúo** grafito y rojo carmín, **mina resistente**.
Bolsa con 4 piezas.



Corrugado: 192 bolsas.



7 502277 581358

Lápiz checador

RCM-10

Lápiz checador en color rojo carmín, azul y verde, no tóxico.
Caja con 10 piezas.



Interno: 12 cajas.
Corrugado: 288 cajas.

RCM-10/4B

Lápiz checador color rojo carmín, no tóxico.
Bolsa con 4 piezas.



Corrugado: 192 bolsas.



BEM-10

Bicolor rojo y azul. Caja con 10 piezas.



Interno: 12 cajas.
Corrugado: 288 cajas.



BEM-10/4B

Bicolor rojo y azul. Bolsa con 4 piezas.



Corrugado: 192 bolsas.



BEM-10J

Bicolor jumbo rojo y azul. Caja con 10 piezas.



Interno: 6 cajas.
Corrugado: 144 cajas.



Crayones

CYM-12T

Crayón escolar triangular, caja con 12 colores diferentes.



Interno: 24 pzas.
Corrugado: 288 pzas.



7 502277 587237

CYM-12JT

Crayón Jumbo triangular escolar, caja con 12 colores diferentes.



Interno: 12 pzas.
Corrugado: 144 pzas.



7 502277 587251

CYM-24T

Crayón escolar triangular, caja con 24 colores diferentes.



Interno: 12 pzas.
Corrugado: 144 pzas.



7 502277 587244

CYM-24JT

Crayón Jumbo triangular escolar, caja con 24 colores diferentes.



Interno: 6 pzas.
Corrugado: 72 pzas.



7 502277 587268

Crayones

CYM-6

Crayón escolar, caja con 6 colores diferentes.



Interno: 24 piezas.
Corrugado: 288 piezas.



7 502277 586063

CYM-6J

Crayón Jumbo escolar, caja con 6 colores diferentes.



Interno: 24 piezas.
Corrugado: 288 piezas.



7 502277 586094

CYM-12

Crayón escolar, caja con 12 colores diferentes.



Interno: 24 pzas.
Corrugado: 288 pzas.



7 502277 586070

CYM-12J

Crayón Jumbo escolar, caja con 12 colores diferentes.



Interno: 12 pzas.
Corrugado: 144 pzas.



7 502277 586100

CYM-24

Crayón escolar, caja con 24 colores diferentes.



Interno: 12 pzas.
Corrugado: 144 pzas.



7 502277 586087

CYM-24J

Crayón Jumbo escolar, caja con 24 colores diferentes.



Interno: 6 pzas.
Corrugado: 72 pzas.



7 502277 586117

Temperas

PTS-12

Pintura tempera sólida, caja con 12 sticks de colores surtidos, no mancha, no tóxico, máxima cobertura al pintar.
Caja con 12 piezas.



Interno: 12 pzas.
Corrugado: 48 pzas.



PTS-6M

Pintura tempera sólida, caja con 6 sticks de colores surtidos metálicos, no mancha, no tóxico, máxima cobertura al pintar.
Caja con 6 piezas.



Interno: 12 pzas.
Corrugado: 48 pzas.



PTS-6N

Pintura tempera sólida, caja con 6 sticks de colores surtidos neón, no mancha, no tóxico, máxima cobertura al pintar.
Caja con 6 piezas.

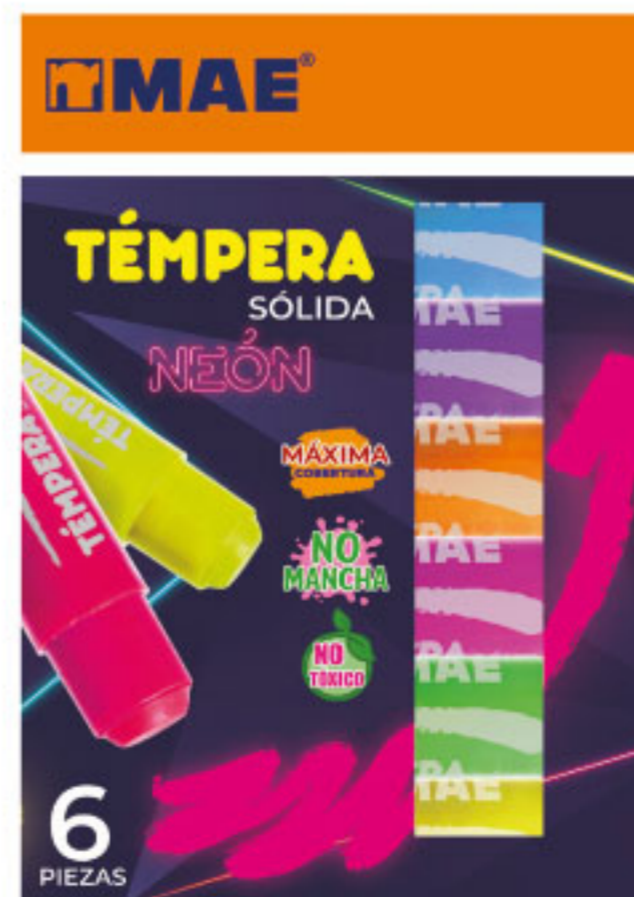

Interno: 12 pzas.
Corrugado: 48 pzas.



Bolígrafos

BTM

Bolígrafo triangular negro, rojo, azul y verde.
Punto mediano. Caja con 12 piezas.



Interno: 12 pzas.
Corrugado: 1,440 pzas.

BTM-10

Bolígrafo triangular en colores surtidos. Punto mediano.
Caja con 10 piezas.



Interno: 72 sets.
Corrugado: 144 sets.



BT7

Bolígrafo triangular negro, rojo y azul. Punto fino.
Caja con 12 piezas.



Ultra Suave



Interno: 12 pzas.
Corrugado: 1,440 pzas.

BTRS

Bolígrafo triangular retráctil en color negro, rojo y azul.
Punto fino. Caja con 12 piezas.



Ultra Suave



Interno: 12 pzas.
Corrugado: 1,440 pzas.

Notas adhesivas

21204-2GBL

Mini cubo pastel de 4 colores con 240 hojas de 2" x 2"
+ 2 gomas de figura.



Corrugado: 56 blisters.



7 502277 581303

21006

Block con 100 hojas de 2" x 3" en color amarillo pastel.
Paquete con 12 piezas.



Interno: 1 paq c/12 pzas.
Corrugado: 12 paquetes.



7 502265 165942

21204

Mini cubo con 240 hojas de 2" x 2" en colores pastel
surtidos: verde, azul, rosa y amarillo.



Interno: 48 cubos.
Corrugado: 288 cubos.



7 502265 165911

21007

Block con 100 hojas de 3" x 3" en color amarillo pastel.
Paquete con 12 piezas.



Interno: 1 paq c/12 pzas.
Corrugado: 18 paquetes.



7 502265 166314

21013

Cubo con 400 hojas de 3" x 3" en colores pastel surtidos:
verde, azul, rosa y amarillo.



Interno: 12 cubos.
Corrugado: 72 cubos.



7 502265 165898

21072

Cubo con 400 hojas de 3" x 3" en color amarillo pastel.



Interno: 12 cubos.
Corrugado: 72 cubos.



7 502265 166352

Notas adhesivas

21328SPO

Notas **surtidas** de 3" x 3" con 100 hojas cada block, colores **pastel**: lila, naranja, verde, azul, rosa y amarillo. Paquete con 12 blocks.



Interno: 1 paq c/12 pzas.
Corrugado: 18 paquetes.



7 502265 165959

21340SPO

Cubo con 400 hojas de 3" x 3" en colores **neón**: azul, amarillo, rosa, naranja, verde y morado.

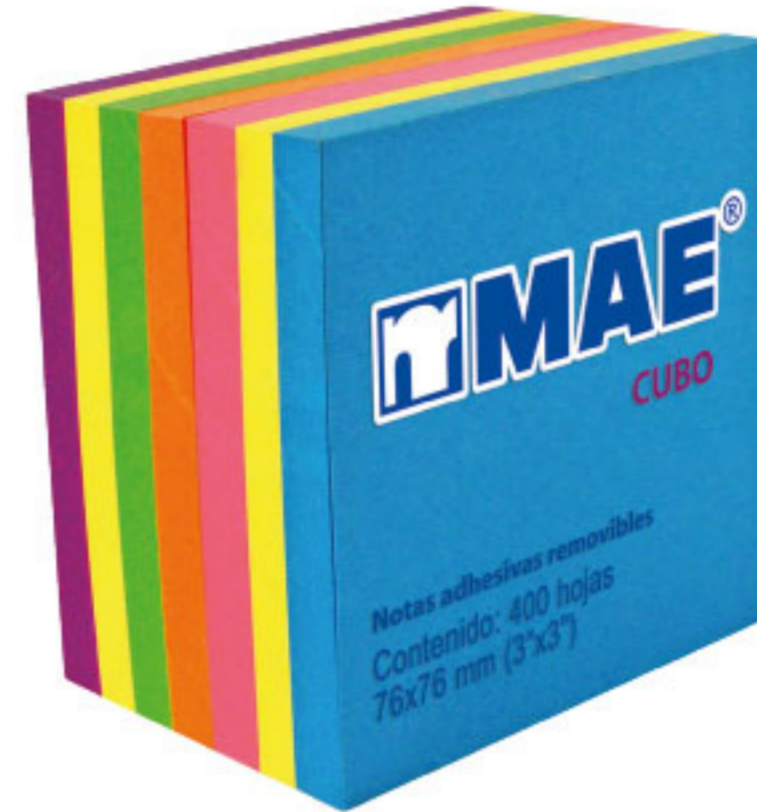

Interno: 12 cubos.
Corrugado: 72 cubos.



7 502265 165980

21331SPO

Notas **surtidas** de 2" x 3" con 100 hojas cada block, colores **neón**: magenta, verde, azul, amarillo, naranja y morado. Paquete con 12 blocks.



Interno: 1 paq c/12 pzas.
Corrugado: 12 paquetes.



7 502265 165966

21332SPO

Notas **surtidas** de 3" x 3" con 100 hojas cada block, colores **neón**: magenta, verde, azul, amarillo, naranja y morado. Paquete con 12 blocks.



Interno: 1 paq c/12 pzas.
Corrugado: 18 paquetes.



7 502265 165973

Notas adhesivas

21203-2GBL

Mini cubo neón de 5 colores con 250 hojas de 2" x 2"
+ 2 gomas de figura.



Corrugado: 56 blisters.



7 502277 581297

21539

Cubo con 400 hojas de 3" x 3" en colores neón: azul,
amarillo, rosa, naranja, verde, morado y blanco.



Interno: 12 cubos.
Corrugado: 72 cubos.



7 502265 166369

21203

Mini cubo con 250 hojas de 2" x 2" en colores neón: verde,
azul, rosa, naranja y amarillo.



Interno: 48 cubos.
Corrugado: 288 cubos.



7 502265 165904

26165

Notas tipo pop up para despachador, block de 100 hojas
de 3" x 3" color amarillo neón.



Interno: 1 paq c/12 pzas.
Corrugado: 18 paquetes.



7 502265 166475

21012

Cubo con 400 hojas de 3" x 3" en colores neón: verde, azul,
rosa, naranja y amarillo.



Interno: 12 cubos.
Corrugado: 72 cubos.



7 502265 165881

21133

Notas de 3" x 3" color amarillo neón, paquete con 12
blocks de 100 hojas cada uno.



Interno: 1 paq c/12 blocks.
Corrugado: 18 paquetes.



Paquete c/12 blocks.
7 502277 585097

Notas adhesivas

21534-2GBL

Mini cubo mix con 250 hojas de 2" x 2" neón y pastel + 2 gomas de figura.



Corrugado: 56 blisters.



7 502277 581310

21535-2GBL

Mini cubo mix con 250 hojas de 2" x 2" neón, pastel y blanco + 2 gomas de figura.



Corrugado: 56 blisters.



7 502277 581327

21534

Mini cubo con 250 hojas de 2" x 2" en colores surtidos.



Interno: 48 cubos.
Corrugado: 288 cubos.



7 502265 166451

21537

Cubo con 400 hojas de 3" x 3" en colores surtidos.



Interno: 12 cubos.
Corrugado: 72 cubos.



7 502265 166376

21538

Cubo con 400 hojas de 3" x 3" en colores surtidos.

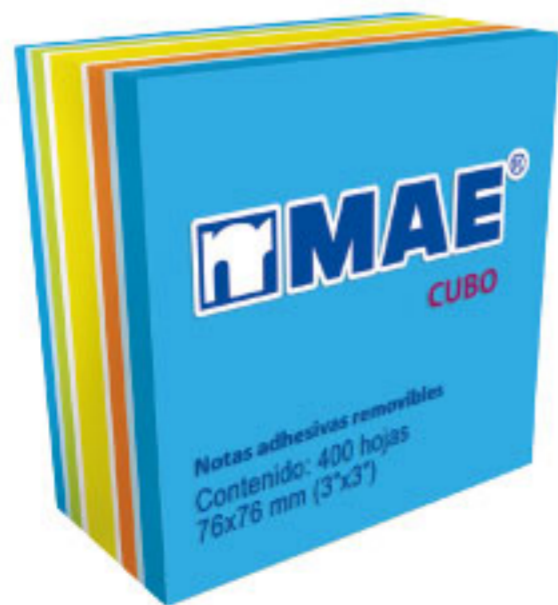

Interno: 12 cubos.
Corrugado: 72 cubos.



7 502265 166321

21091

Notas neón surtidas, 4 blocks de 1.5" x 2" con 50 hojas c/u.



Interno: 24 pzas.
Corrugado: 288 pzas.



7 502265 166499

Notas adhesivas

21369

Notas rompecabezas multicolor neón surtido. 150 hojas de cada color.



Interno: 6 pzas.
Corrugado: 36 pzas.



7 502265 166383

21346

Notas de índice, 200 hojas en 8 colores neón, figura rectangular y de flecha.



Interno: 24 pzas.
Corrugado: 288 pzas.



7 502265 166079

26002

Notas de índice con despachador. 200 hojas en colores neón: verde, amarillo, naranja, rosa y morado.



Interno: 24 pzas.
Corrugado: 288 pzas.



7 502265 165935

26003

Notas de índice con despachador en forma de flecha. 150 hojas en colores: rojo, naranja, amarillo, verde y azul.



Interno: 24 pzas.
Corrugado: 288 pzas.



7 502265 166093

21051

Notas de índice, 100 hojas en colores neón: amarillo, naranja, verde y rosa.



Interno: 1 caja c/ 24 pzas.
Corrugado: 24 cajas.



7 502265 166338

21401

Notas de índice, 160 hojas en 8 colores neón diferentes.



Interno: 1 caja c/ 24 pzas.
Corrugado: 24 cajas.



7 502265 166086

Notas adhesivas

21359

Etiquetas para indicar y organizar documentos y archivos.
30 hojas de 37 x 50 mm.



Interno: 24 pzas.
Corrugado: 288 pzas.



7 502265 165997

21356

Notas adhesivas en forma de **corazón**. 250 hojas de
64 x 67 mm. Colores neón.

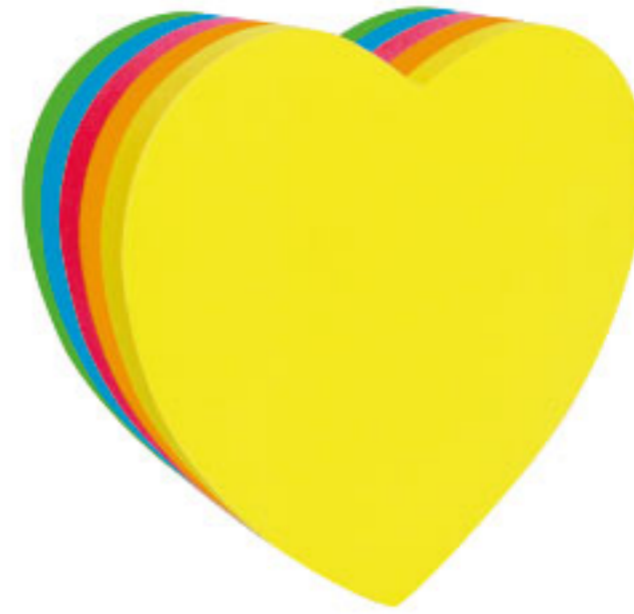

Interno: 18 pzas.
Corrugado: 108 pzas.



7 502265 166000

21357

Notas adhesivas en forma de **flor**. 250 hojas de
67 x 67 mm. Colores neón.



Interno: 18 pzas.
Corrugado: 108 pzas.



7 502265 166017

21358

Notas adhesivas en forma de **círculo**. 250 hojas de
67 x 67 mm. Colores neón.

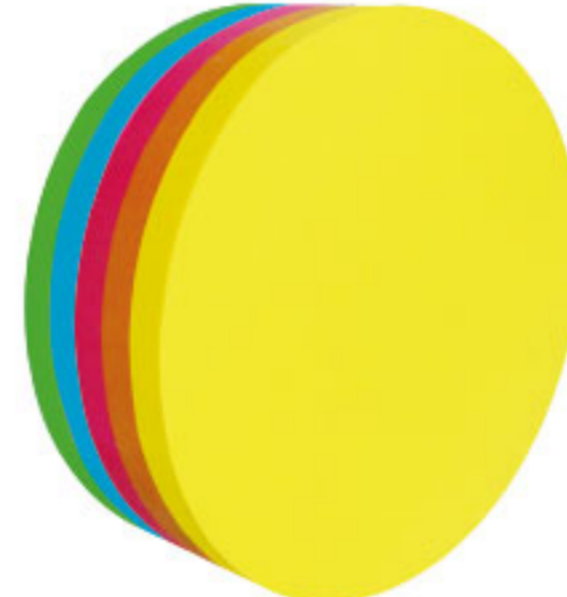

Interno: 18 pzas.
Corrugado: 108 pzas.



7 502265 166062

21277

Notas adhesivas en forma de **manzana**
con **porta pluma** integrado.
400 hojas de 3" x 3" (76 x 76 mm).
Colores neón.



Interno: 12 pzas.
Corrugado: 72 pzas.



7 502265 165928

Notas adhesivas

332501

Notas adhesivas en forma de **conejo**.
250 hojas de 70.2 x 60 mm. Colores neón.

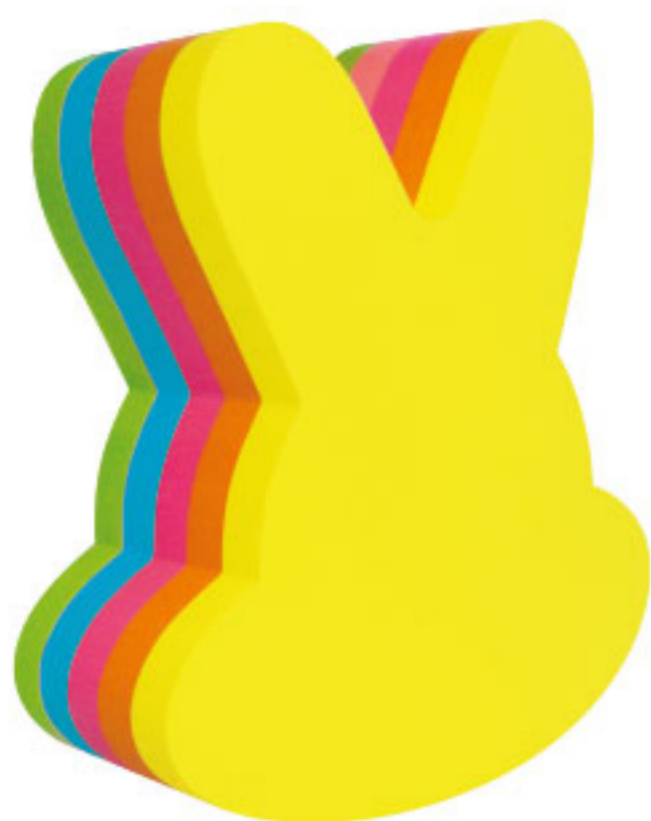

Interno: 18 pzas.
Corrugado: 108 pzas.



7 502265 166048

332502

Notas adhesivas en forma de **árbol**.
250 hojas de 70.2 x 60 mm. Colores neón.

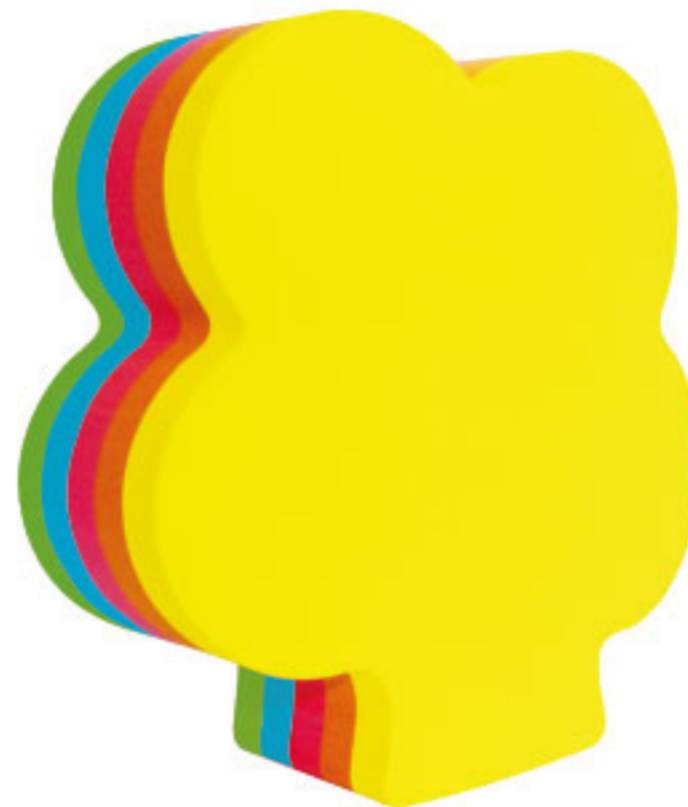

Interno: 18 pzas.
Corrugado: 108 pzas.



7 502265 166031

332503

Notas adhesivas en forma de **oso**.
250 hojas de 70.2 x 60 mm. Colores neón.

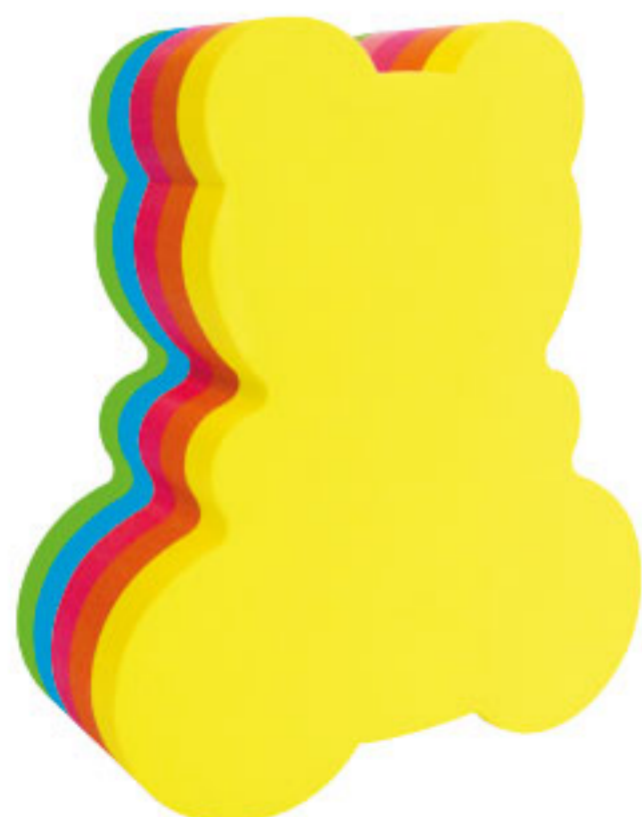

Interno: 18 pzas.
Corrugado: 108 pzas.



7 502265 166024

332504

Notas adhesivas en forma de **estrella**.
250 hojas de 70 x 65 mm. Colores neón.



Interno: 18 pzas.
Corrugado: 108 pzas.



7 502265 166055



21821

Notas intercaladas de 3" x 3" con 100 hojas cada block, colores **pastel**: rosa, verde, azul y amarillo. Paquete con 12 blocks.



Interno: 1 paq c/12 pzas.
Corrugado: 18 paquetes.



7 502277 588647

21822

Notas intercaladas de 3" x 3" con 100 hojas cada block, colores **neón**: magenta, verde, azul y amarillo. Paquete con 12 blocks.



Interno: 1 paq c/12 pzas.
Corrugado: 18 paquetes.



7 502277 588654

21571

Notas 4 colores en 1 de 3" x 3" en colores **neón**: amarillo, azul, rosa y verde. Block de 100 hojas.



¡Ahora tú eliges el color que quieras!



Interno: 1 paq c/12 pzas.
Corrugado: 18 paquetes.



4 712759 215715

21574

Notas 4 colores en 1 de 3" x 3" en colores **pastel**: amarillo, azul, rosa y verde. Block de 100 hojas.



¡Ahora tú eliges el color que quieras!



Interno: 1 paq c/12 pzas.
Corrugado: 18 paquetes.



4 712759 215746



21005

Notas de 1.5" x 2" en color amarillo pastel.
Caja con 12 blocks de 100 hojas c/u.



Interno: 1 caja c/12 blocks.
Corrugado: 36 cajas.



4 712759 210055

21008

Block con 100 hojas de 4" x 3" en color amarillo pastel.
Paquete con 12 piezas.



Interno: 1 paq c/12 blocks.
Corrugado: 12 paquetes.



4 712759 900994

21364

Notas de 3" x 3" color amarillo pastel y neón. 2 blocks con 100 hojas cada uno. ¡Gratis notas de índice!



Interno: 12 pzas.
Corrugado: 144 pzas.



4 712759 213643

21579

Block con 90 hojas rayadas de 4" x 6" en colores pastel: amarillo, rosa y verde. Caja con 6 blocks.



¡Ahora tú eliges el color que quieras!



Interno: 1 caja c/6 pzas.
Corrugado: 12 cajas.



4 712759 215791



21475

75 notas de índice más 20 notas adhesivas en forma de manzana.



Interno: 24 pzas.
Corrugado: 288 pzas.



4 712759 214756

21487

Notas para organizar, 100 hojas de 70 x 70 mm con pestaña de color.



Interno: 12 blisters.
Corrugado: 144 blisters.



4 712759 214879

21477

75 notas de índice más 20 notas adhesivas en forma de corazón.



Interno: 24 pzas.
Corrugado: 288 pzas.



4 712759 214770

21101

50 hojas plásticas semitransparentes de 3" x 3" color amarillo neón.



**ESCRIBE
SOBRE ELLAS**



Interno: 18 blisters.
Corrugado: 216 blisters.



4 712759 211014



21607

Etiquetas para indicar, organizar documentos y archivos.
80 etiquetas de 38 x 25 mm.



Interno: 24 pzas.
Corrugado: 288 pzas.



21423

Notas mágicas escalera, 150 hojas colores neón:
naranja, amarillo, verde, azul y rosa.



Interno: 12 blisters.
Corrugado: 72 blisters.



21608

Etiquetas para indicar, organizar documentos y archivos.
24 etiquetas de 38 x 51 mm.

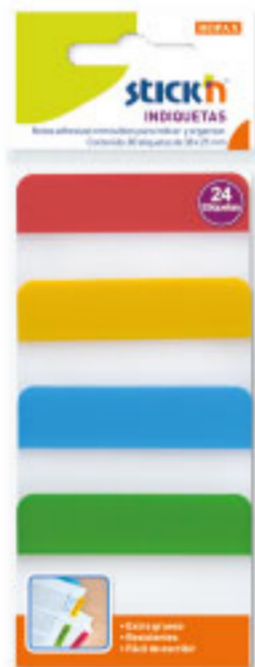

Interno: 24 pzas.
Corrugado: 288 pzas.



21258

Notas neón surtidas, 3 blocks de 50 hojas c/u.
Medidas: 3" x 2", 3" x 3" y 5" x 3".



Interno: 12 pzas.
Corrugado: 144 pzas.



21609

Etiquetas para indicar, organizar documentos y archivos.
24 etiquetas de 38 x 76 mm.

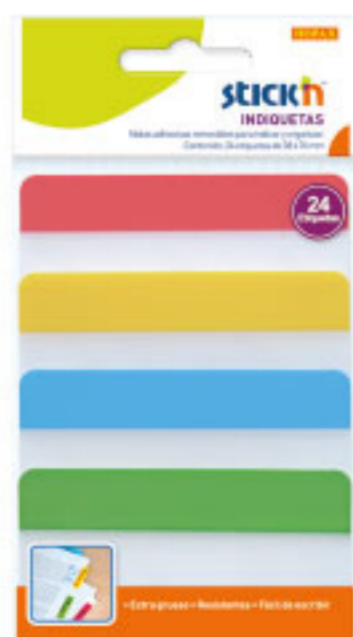

Interno: 24 pzas.
Corrugado: 288 pzas.



POLIPROPILENO

Fabric

SLO-1

Sobre porta documentos tamaño **oficio** con **liga**.



Corrugado: 50 pzas.



7 502277 582386

FP-1

Folder tamaño **carta** con **broche** metálico tipo **palanca**.



Interno: 12 pzas.
Corrugado: 120 pzas.



7 502212 171750

SL-1

Sobre porta documentos tamaño **carta** con **liga**.



Interno: 12 pzas.
Corrugado: 72 pzas.



7 502212 171729

Fabric

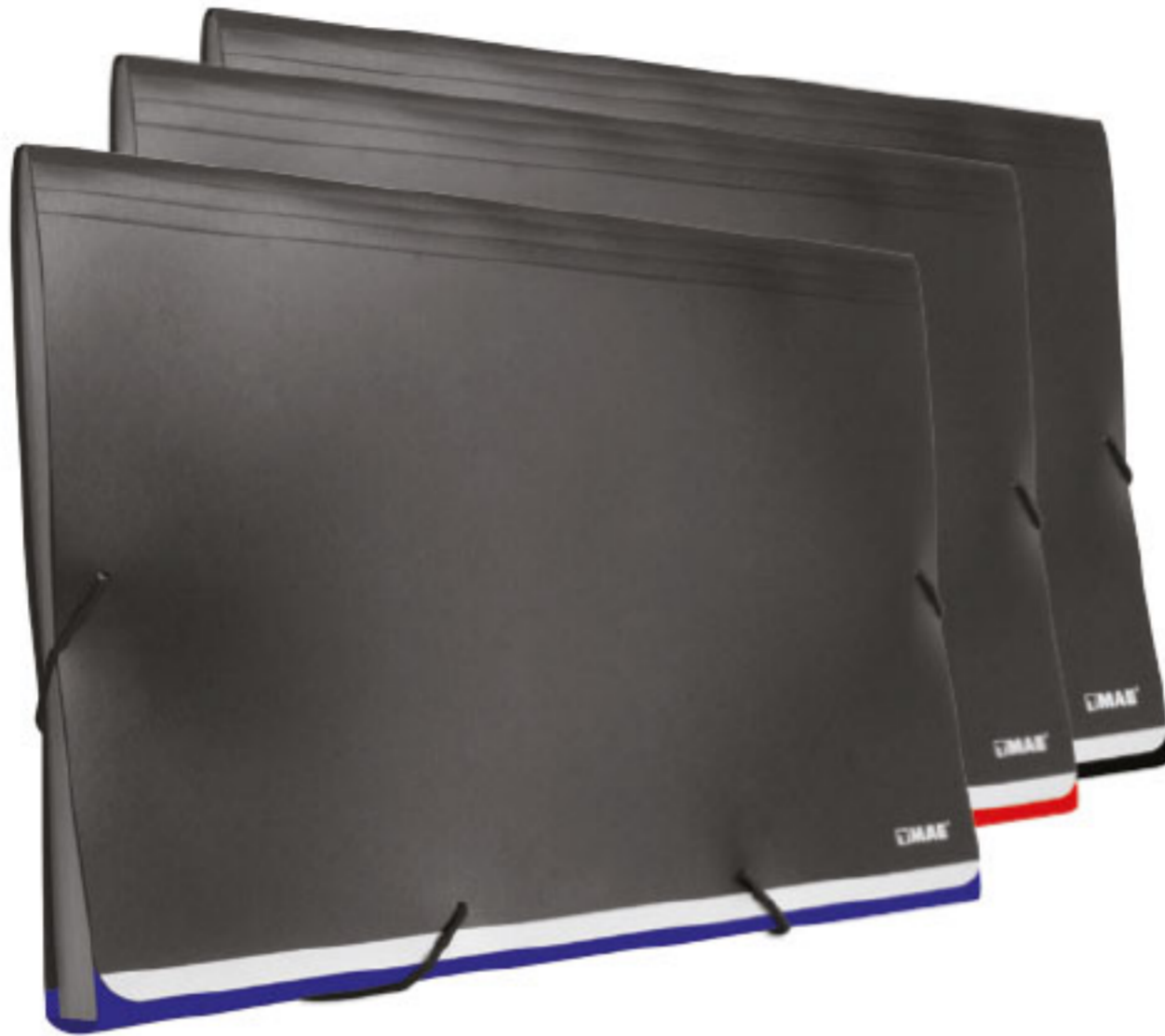
KFC-12Archivador expandible tamaño **oficio** con 12 divisiones.

Interno: 16 pzas.
Corrugado: 32 pzas.



7 502212 171682

KA4-12Archivador expandible tamaño **carta** con 12 divisiones.

Interno: 24 pzas.
Corrugado: 48 pzas.



7 502212 171699

Fabric

AL-6

Carpeta tipo ejecutivo, con archivador expandible de 6 divisiones y block de hojas rayadas.

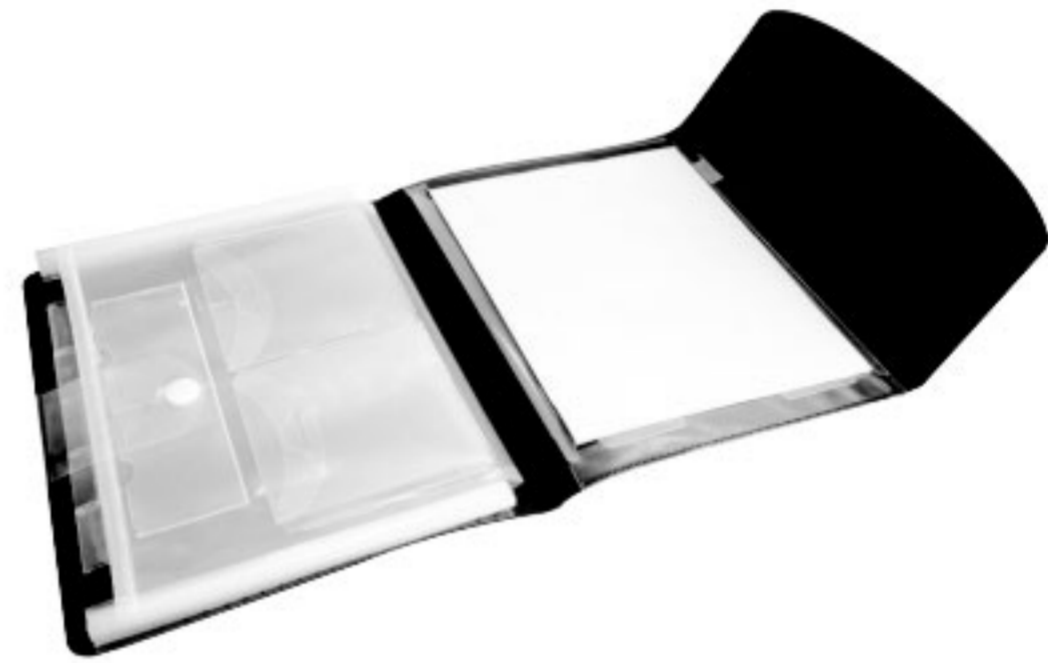

Interno: 24 pzas.
Corrugado: 48 pzas.



7 502212 171712

KCH-12

Archivador expandible tamaño chequera con 12 divisiones.



Interno: 36 pzas.
Corrugado: 72 pzas.



7 502212 171705

FA-3

Folder tamaño carta con 3 argollas de 1".



Interno: 12 pzas.
Corrugado: 60 pzas.



7 502212 171767

COLORSENSES

CAA-1CS

Archivador con asa tamaño **oficio**.



Interno: 8 pzas.
Corrugado: 24 pzas.



7 502237 302849

CL-1CS

Caja porta documentos tamaño **carta** con **liga**.



Interno: 12 pzas.
Corrugado: 60 pzas.



7 502237 302788

FA-3CS

Folder tamaño **carta** con 3 argollas de 1".



Interno: 12 pzas.
Corrugado: 60 pzas.



7 502237 302801

COLORSENSES

SLO-1CS

Sobre porta documentos tamaño **oficio** con **liga**.



Corrugado: 50 pzas.



7 502277 582393

FP-1CS

Folder tamaño **carta** con **broche** metálico tipo **palanca**.



Interno: 12 pzas.
Corrugado: 120 pzas.



7 502237 302733

SL-1CS

Sobre porta documentos tamaño **carta** con **liga**.



Interno: 12 pzas.
Corrugado: 72 pzas.



7 502237 302795

A4-12CS

Archivador expandible tamaño **carta** con **12 divisiones**.



Interno: 12 pzas.
Corrugado: 48 pzas.



7 502237 302740

COLORSENSES

KCH-12CS

Archivador expandible tamaño **chequera** con 12 divisiones.



Interno: 18 pzas.
Corrugado: 72 pzas.



7 502237 302764

FC-12CS

Archivador expandible tamaño **oficio** con 12 divisiones.



Interno: 12 pzas.
Corrugado: 36 pzas.



7 502237 302757

CLB

Folder de plástico tamaño **carta** con protectores de hojas transparentes.

CLB-10CS

con 10 protectores.



CLB-20CS

con 20 protectores.



CLB-30CS

con 30 protectores.



Interno: 12 pzas.
Corrugado: 120 pzas.

CLB-10CS



7 502237 302818

CLB-20CS



7 502237 302825

CLB-30CS



7 502237 302832

PECB-10

Cubierta para encuadernar tamaño **carta**. Bolsa con **10 pares**.

PECB-10W



PECB-10C



PECB-10S



PECB-10P



Interno: 1 bolsa.
Corrugado: 21 bolsas.

PECB-10W



PECB-10C



PECB-10S



PECB-10P



FPCB

Folder tamaño **carta** con **broche** metálico tipo **palanca**.

FPCB-W



FPCB-S



FPCB-P



Interno: 12 pzas.
Corrugado: 72 pzas.

FPCB-W



FPCB-S



FPCB-P



CRACK & BONKY. 

CB-016

Bolsa para regalo con **asa de cordón**. Medidas: 29 x 31 x 12 cm.



Interno: 60 pzas.
Corrugado: 120 pzas.

CB-016W



7 502237 303211

ELCB

Estuche **porta lápices** con broche.



ELCB-S



7 502237 303105



ELCB-C



7 502237 303099











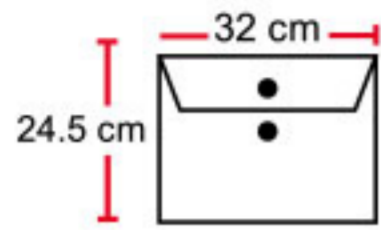



Interno: 28 pzas.
Corrugado: 224 pzas.

Sobres con hilo

SHAH / SHFH

Sobre con hilo tamaño carta horizontal.









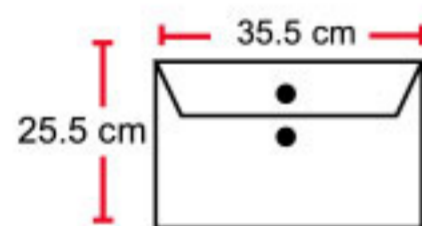

	<p>SHAH Surtido</p>  <p>7 502212 172351</p>	<p>SHAH-AM Amarillo</p>  <p>7 502212 173105</p>
<p>SHAH-VE Verde</p>  <p>7 502212 173082</p>	<p>SHAH-TR Transparente</p>  <p>7 502212 173075</p>	<p>SHAH-MO Morado</p>  <p>7 502212 178018</p>
<p>SHAH-HU Humo</p>  <p>7 502212 174423</p>	<p>SHAH-AZ Azul</p>  <p>7 502212 173099</p>	<p>SHAH-NA Naranja</p>  <p>7 502212 177936</p>
<p>SHAH-RS Rosa</p>  <p>7 502212 173068</p>	<p>SHAH-AO Azul oscuro</p>  <p>7 502212 177974</p>	<p>SHAH-RJ Rojo</p>  <p>7 502265 165256</p>



Sobre con hilo tamaño oficio horizontal.



	<p>SHFH Surtido</p>  <p>7 502212 172344</p>	<p>SHFH-AM Amarillo</p>  <p>7 502212 173051</p>
<p>SHFH-VE Verde</p>  <p>7 502212 173037</p>	<p>SHFH-TR Transparente</p>  <p>7 502212 173020</p>	<p>SHFH-MO Morado</p>  <p>7 502212 178001</p>
<p>SHFH-HU Humo</p>  <p>7 502212 174416</p>	<p>SHFH-AZ Azul</p>  <p>7 502212 173044</p>	<p>SHFH-NA Naranja</p>  <p>7 502212 177929</p>
<p>SHFH-RS Rosa</p>  <p>7 502212 173013</p>	<p>SHFH-AO Azul oscuro</p>  <p>7 502212 177967</p>	<p>SHFH-RJ Rojo</p>  <p>7 502265 165263</p>



Códigos de barras por paquetes de 12 piezas.



Interno: 5 paq c/12 pzas.
Corrugado: 30 paquetes.

Sobres con hilo

SHAV / SHFV

Sobre con hilo tamaño carta vertical.

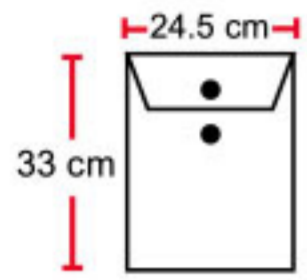

SHAV
Surtido



SHAV-AM
Amarillo



SHAV-VE
Verde



SHAV-TR
Transparente



SHAV-MO
Morado



SHAV-HU
Humo



SHAV-AZ
Azul



SHAV-NA
Naranja



SHAV-RS
Rosa



SHAV-AO
Azul oscuro



SHAV-RJ
Rojo



Sobre con hilo tamaño oficio vertical.

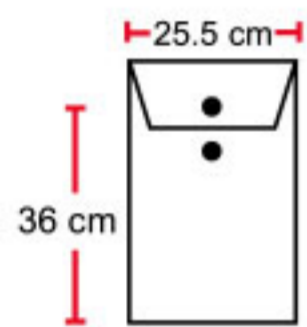

SHFV
Surtido



SHFV-AM
Amarillo



SHFV-VE
Verde



SHFV-TR
Transparente



SHFV-MO
Morado



SHFV-HU
Humo



SHFV-AZ
Azul



SHFV-NA
Naranja



SHFV-RS
Rosa



SHFV-AO
Azul oscuro



SHFV-RJ
Rojo



Códigos de barras por
paquetes de 12 piezas.



Interno: 5 paq c/12 pzas.
Corrugado: 30 paquetes.

Sobres con hilo

COLORES PASTEL

Sobre con hilo tamaño **carta y oficio**, horizontal y vertical en **6 colores surtidos**.
Paquete con **12 piezas** en colores surtidos.



Interno: 5 paq c/12 pzas.
Corrugado: 30 paquetes.

SHAH-PS
carta horizontal



7 502286 762250

SHFH-PS
oficio horizontal



7 502286 762212

SHAV-PS
carta vertical



7 502286 762236

SHFV-PS
oficio vertical



7 502286 762199

COLORES SÓLIDOS

Sobre con hilo tamaño **carta y oficio**, horizontal y vertical en **6 colores surtidos**.
Paquete con **12 piezas** en colores surtidos.



Interno: 5 paq c/12 pzas.
Corrugado: 30 paquetes.

SHAH-SS
carta horizontal



7 502286 762243

SHFH-SS
oficio horizontal



7 502286 762205

SHAV-SS
carta vertical



7 502286 762229

SHFV-SS
oficio vertical



7 502286 762182

Sobres

SHM

Sobre plástico tipo manila tamaño carta, oficio y esquila vertical.
Paquete con 10 piezas.

SHM-E



SHM-C



SHM-O



SHM-E
esquila vertical



Interno: 10 paq c/10 pzas.
Corrugado: 60 paquetes.

7 502277 588555

SHM-C
carta vertical



Interno: 5 paq c/10 pzas.
Corrugado: 30 paquetes.

7 502277 588531

SHM-O
oficio vertical



7 502277 588579

SHEV

Sobre con hilo tipo esquila.
Paquete con 12 piezas en colores surtidos.



Interno: 30 paquetes.
Corrugado: 60 paquetes.



7 502237 308865

5PCK-ZIP

Sobre con cierre deslizable de plástico tamaño carta.
Paquete con 5 piezas en colores surtidos.



Interno: 1 paq c/5 pzas.
Corrugado: 60 paquetes.



7 502277 580030

Sobres

5PCK-FOB

Sobre con broche tamaño carta horizontal. Paquete con 5 piezas en colores surtidos.



COLORES
MÁS
INTENSOS



Interno: 1 paq c/5 pzas.
Corrugado: 48 paquetes.



7 502212 174331

SBAH

Sobre con broche tamaño carta horizontal. Paquete con 12 piezas en colores surtidos.

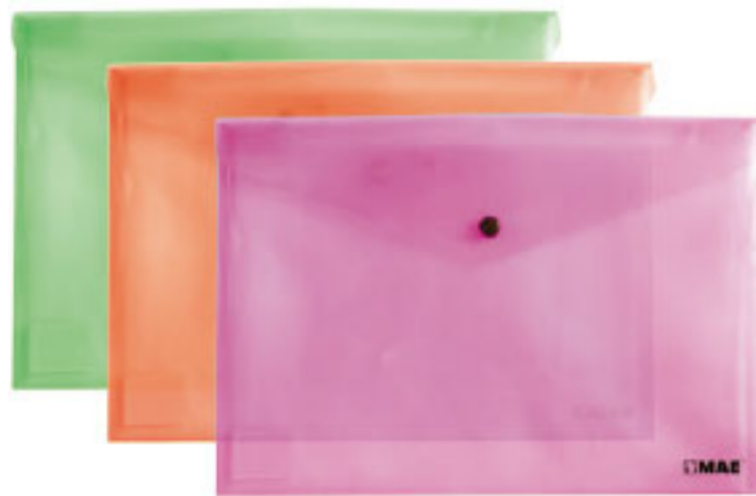

COLORES
MÁS
INTENSOS



Interno: 30 paq c/12 pzas.
Corrugado: 60 paquetes.

					<p>SBAH Surtido</p> <p>7 502212 176045</p>					
<p>SBAH-AM Amarillo</p> <p>7 502212 176052</p>	<p>SBAH-AZ Azul</p> <p>7 502212 179862</p>	<p>SBAH-AO Azul oscuro</p> <p>7 502277 586797</p>	<p>SBAH-MO Morado</p> <p>7 502277 586766</p>	<p>SBAH-NA Naranja</p> <p>7 502277 586773</p>						
<p>SBAH-HU Humo</p> <p>7 502212 179886</p>	<p>SBAH-TR Transparente</p> <p>7 502212 179879</p>	<p>SBAH-RJ Rojo</p> <p>7 502277 586803</p>	<p>SBAH-RS Rosa</p> <p>7 502277 586780</p>	<p>SBAH-VE Verde</p> <p>7 502277 586759</p>						

SBFH

Sobre con broche tamaño oficio horizontal. Paquete con 12 piezas en colores surtidos.



COLORES
MÁS
INTENSOS



Interno: 20 paq c/12 pzas.
Corrugado: 40 paquetes.

					<p>SBFH Surtido</p> <p>7 502212 179893</p>					
<p>SBFH-AZ Azul</p> <p>7 502212 179916</p>	<p>SBFH-AM Amarillo</p> <p>7 502212 179909</p>	<p>SBFH-AO Azul oscuro</p> <p>7 502277 586858</p>	<p>SBFH-MO Morado</p> <p>7 502277 586827</p>	<p>SBFH-NA Naranja</p> <p>7 502277 586834</p>						
<p>SBFH-HU Humo</p> <p>7 502212 179930</p>	<p>SBFH-TR Transparente</p> <p>7 502212 179923</p>	<p>SBFH-RJ Rojo</p> <p>7 502277 586865</p>	<p>SBFH-RS Rosa</p> <p>7 502277 586841</p>	<p>SBFH-VE Verde</p> <p>7 502277 586810</p>						

Folders

FC-1

Folder blanco traslúcido tamaño **carta**, con **clip plástico** de colores.



Interno: 12 pzas.
Corrugado: 240 pzas.



7 502212 171743

5PCK-FOC

Folder con **clip deslizable** de plástico tamaño **carta**. Paquete con **5** piezas en colores surtidos.



Interno: 1 paq c/5 pzas.
Corrugado: 60 paquetes.



7 502212 174324

FL-10

Folder transparente **sellado en "L"** tamaño **carta**. Paquete con **10** piezas.



Interno: 12 paquetes.
Corrugado: 120 paquetes.



7 502237 309749

FTC-10

Folder transparente con **costilla** de colores, tamaño **carta**. Paquete con **10** piezas en colores **surtidos**.



Interno: 12 paquetes.
Corrugado: 60 paquetes.



7 502265 160022

Folders

FCC-10

Folder de colores con **costilla** tamaño **carta**.
Paquete con **10** piezas en colores **surtidos**.



Interno: 12 paquetes.
Corrugado: 60 paquetes.



7 502237 309725

FCC-10VE

Folder con **costilla** tamaño **carta**.
Paquete con **10** piezas de color **verde**.



Interno: 12 paquetes.
Corrugado: 60 paquetes.



7 502265 160923

FCC-10R

Folder con **costilla** tamaño **carta**.
Paquete con **10** piezas de color **rojo**.



Interno: 12 paquetes.
Corrugado: 60 paquetes.



7 502265 160930

FCC-10AZ

Folder con **costilla** tamaño **carta**.
Paquete con **10** piezas de color **azul**.



Interno: 12 paquetes.
Corrugado: 60 paquetes.



7 502265 160879

Folders

FCC-10HU

Folder con **costilla** tamaño **carta**.
Paquete con **10** piezas de color **humo**.

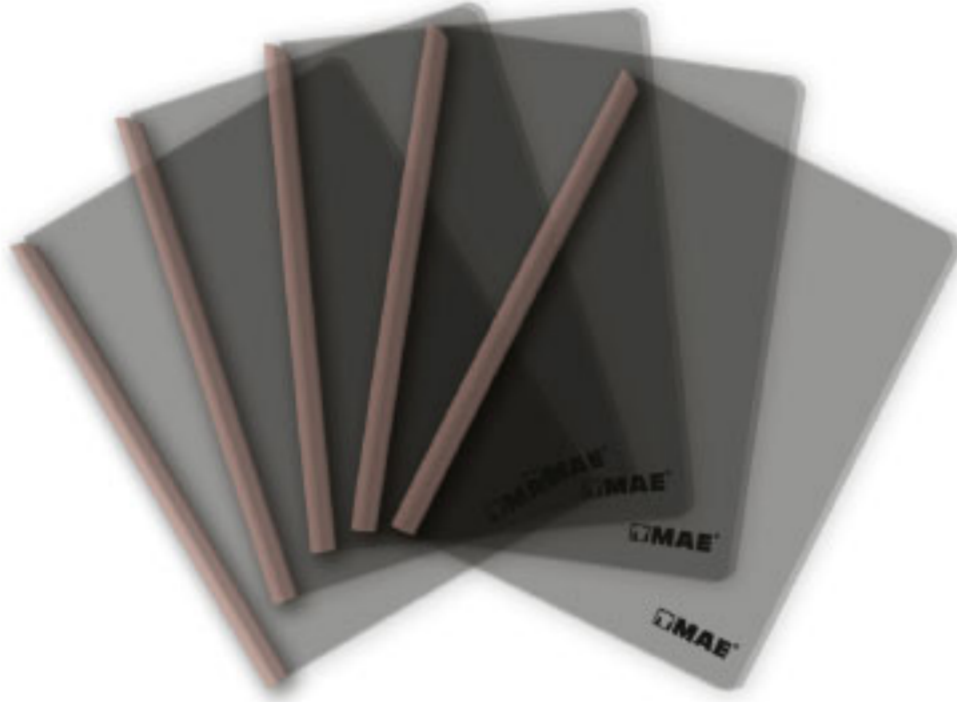

Interno: 12 paquetes.
Corrugado: 60 paquetes.



7 502265 160909

FCC-10RS

Folder con **costilla** tamaño **carta**.
Paquete con **10** piezas de color **rosa**.



Interno: 12 paquetes.
Corrugado: 60 paquetes.



7 502265 160916

FCC-10AM

Folder con **costilla** tamaño **carta**.
Paquete con **10** piezas de color **amarillo**.



Interno: 12 paquetes.
Corrugado: 60 paquetes.



7 502265 160886

FCC-10TR

Folder con **costilla** tamaño **carta**.
Paquete con **10** piezas **transparentes**.



Interno: 12 paquetes.
Corrugado: 60 paquetes.



7 502265 160893

Carpeta con palanca

CPS

Carpeta con palanca, tamaño **carta** de colores **sólidos**, ideal para organizar los documentos..



Colores:



Interno: 12 piezas.
Corrugado: 60 piezas.

Carpeta con palanca

CPT

Carpeta con palanca, tamaño carta de colores translúcidos, ideal para organizar los documentos..



Colores:



CPT-AM



CPT-AZ



CPT-HU



CPT-RS



CPT-TR



CPT-VE



Interno: 12 piezas.
Corrugado: 60 piezas.

Cubiertas para encuadernar

CUBIERTAS

Cubiertas para encuadernar con **textura de diagonales** (Twill).
Paquete con **25 pares** tamaño **carta** (22 x 28.5 cm).

PENT-25



Negro

PET02-25



Verde

PET07-25



Rojo

PEFS-25



Surtido neón en 5 colores,
5 pares de cada color.

PEAT-25



Azul oscuro

PET03-25



Rosa

PET09-25



Azul claro

PEVT-25



Vino

PET04-25



Azul

PET10-25



Café



PETT-25



Transparente

PET05-25



Gris

PET11-25



Amarillo

PET01-25



SURTIDO EN 5 COLORES
5 PARES DE CADA UNO.

PET06-25



Morado

PET14-25



Naranja

Códigos de barras por
paquetes de 25 pares.

PENT-25



7 502212 171439

PEAT-25



7 502212 171446

PEVT-25



7 502212 171422

PETT-25



7 502212 171408

PET01-25



7 502212 174133

PET02-25



7 502212 172061

PET03-25



7 502212 172078

PET04-25



7 502212 172085

PET05-25



7 502212 172092

PET06-25



7 502212 172108

PET07-25



7 502212 172115

PET09-25



7 502212 172139

PET10-25



7 502212 172146

PET11-25



7 502212 172153

PET14-25



7 502212 172184

PEFS-25



7 502265 165706



Interno: 1 paq c/25 pares.
Corrugado: 20 paquetes.

Cubiertas para encuadernar

PES

Cubiertas para encuadernar **sólidas**, tamaño **carta** (22 x 28.5 cm). Paquete con **25 pares**.



Códigos de barras por paquetes de 25 pares.



PESA-25

Azul



PESN-25

Negro



PEST-25

Semi transparente



Interno: 1 paq c/25 pares.
Corrugado: 20 paquetes.

PEO

Cubiertas para encuadernar con **textura de diagonales** (Twill), tamaño **oficio** (22 x 34.4 cm). Paquete con **25 pares**.



Códigos de barras por paquetes de 25 pares.



PEOT-25

Surtido



PEOTT-25

Transparente



PEONT-25

Negro



Interno: 1 paq c/25 pares.
Corrugado: 10 paquetes.

PEOS

Cubiertas para encuadernar **sólidas**, tamaño **oficio** (22 x 34.4 cm). Paquete con **25 pares**.

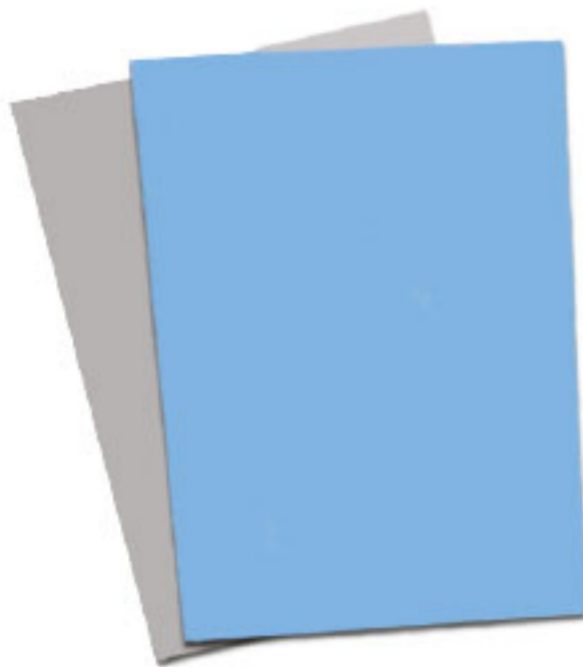

Códigos de barras por paquetes de 25 pares.



PEOS05-25

Gris



PEOSA-25

Azul



Interno: 1 paq c/25 pares.
Corrugado: 10 paquetes.

Arillos para encuadernar

TEP - 7/8

Arillo plástico para encuadernar. Medida: 7/8" (22 mm). Bolsa con 25 piezas.



Interno: 1 bolsa c/25 pzas.
Corrugado: 23 bolsas.



7 502265 161296

TEP - 1 1/8

Arillo plástico para encuadernar. Medida: 1 1/8" (28 mm). Bolsa con 25 piezas.



Interno: 1 bolsa c/25 pzas.
Corrugado: 13 bolsas.



7 502265 161319

PB-004-1

Caja de regalo tipo **mini bolsita**, colores surtidos.
Medidas: 6.5 x 9 x 3.8 cm.



Interno: 100 pzas.
Corrugado: 400 pzas.



7 502212 170999

PB-005

Caja de regalo **con asa**, colores surtidos.
Medidas: 15.4 x 11.7 x 10.2 cm.



Interno: 48 pzas.
Corrugado: 192 pzas.



7 502212 171002

Bolsas para regalo

CX-006

Caja de regalo tipo **bolsita**, colores surtidos.
Medidas: 12 x 6.5 x 8.5 cm.



Interno: 100 pzas.
Corrugado: 400 pzas.



7 502212 171019

LX-008

Caja de regalo, colores surtidos.
Medidas: 15 x 15 x 10 cm.



Interno: 50 pza.
Corrugado: 200 pzas.



7 502212 170876

LX-024

Caja de regalo tipo **almohada chica** colores surtidos.
Medidas: 26 x 20 x 6 cm.



Interno: 50 pzas.
Corrugado: 200 pzas.



7 502212 170951

LX-025 (G)

Caja de regalo tipo **almohada grande**
colores surtidos. Medidas: 42 x 26.5 x 8.5 cm.



Interno: 50 pzas.
Corrugado: 100 pzas.



7 502212 171101

Bolsas para regalo

LX-023

Caja de regalo **tipo corbata**, colores surtidos.
Medidas: 9.5 x 36 cm.



Interno: 50 pzas.
Corrugado: 100 pzas.



7 502212 170944

LAX-07

Caja de regalo **para botellas**, colores surtidos.
Medidas: 9.3 x 9 x 36.5 cm.



Interno: 48 pzas.
Corrugado: 192 pzas.



7 502212 170814

LX-004

Caja de regalo **tipo tulipán**, colores surtidos.
Medidas: 11.5 x 11.5 x 11.5 cm.



Interno: 48 pzas.
Corrugado: 192 pzas.



7 502212 170869

LX-011 (M)

Caja de regalo **mediana con moño**, colores surtidos. Medidas: 12 x 8.5 x 8 cm.



Interno: 48 pzas.
Corrugado: 192 pzas.



7 502212 170913

LX-011 (L)

Caja de regalo **grande con moño**, colores surtidos. Medidas: 19 x 12.8 x 12.2 cm.



Interno: 48 pzas.
Corrugado: 192 pzas.



7 502212 170890

CX-021

Bolsa con **asa de cordón**.
Medidas: 40.6 x 30.4 x 15 cm.



Interno: 20 pzas.
Corrugado: 60 pzas.



7 502212 171095

SUPLEMENTOS DE OFICINA

Ligas

ML-10

Ligas de hule del número 10, caja con 100 gramos.



Interno: 1 caja.
Corrugado: 100 cajas.



7 502265 166598

ML-10B

Ligas de hule del número 10, bolsa con 80 gramos.



Interno: 1 bolsa.
Corrugado: 125 bolsas.



7 502265 166574

ML-18

Ligas de hule del número 18, caja con 100 gramos.



Interno: 1 caja.
Corrugado: 100 cajas.



7 502265 166581

ML-18B

Ligas de hule del número 18, bolsa con 80 gramos.



Interno: 1 bolsa.
Corrugado: 125 bolsas.



7 502265 166567

ML-33

Ligas de hule del número 33, caja con 100 gramos.



Interno: 1 caja.
Corrugado: 100 cajas.



7 502265 166635

ML-33B

Ligas de hule del número 33, bolsa con 80 gramos.



Interno: 1 bolsa.
Corrugado: 125 bolsas.



7 502265 166628

Ligas

MLP-18B

Ligas de hule **premium** del número 18, bolsa con 100 gramos.



Interno: 1 bolsa.
Corrugado: 100 bolsas.



MLP-64B

Ligas de hule **premium** del número 64, bolsa con 100 gramos.



Interno: 1 bolsa.
Corrugado: 100 bolsas.



MLC-10B

Ligas de hule de **colores** del número 10, bolsa con 80 gramos.



Interno: 1 bolsa.
Corrugado: 125 bolsas.



MLC-18B

Ligas de hule de **colores** del número 18, bolsa con 80 gramos.



Interno: 1 bolsa.
Corrugado: 125 bolsas.



Portagafetes

GFS-10

GFS-10HB:

Porta gafetes de plástico sólido horizontal.

Medida de la tarjeta interna: 9 x 5.5 cm, bolsa con 10 juegos.



GFS-10VB:

Porta gafete de plástico sólido vertical.

Medida de la tarjeta interna: 5.5 x 9 cm, bolsa con 10 juegos.



Interno: 30 bolsas con 10 juegos c/u.
Corrugado: 180 bolsas.

GFS-10HB



GFS-10VB



GFS-10

GFS-10H:

Porta gafetes de plástico sólido horizontal.

Medida de la tarjeta interna: 9 x 5.5 cm, caja con 50 juegos.



GFS-10V:

Porta gafete de plástico sólido vertical.

Medida de la tarjeta interna: 5.5 x 9 cm, caja con 50 juegos.



Interno: 1 caja con 50 juegos c/u.
Corrugado: 40 cajas.

GFS-10H



GFS-10V



GFT-10

GFT-10VC:

Porta gafete de PVC transparente vertical con cordón.

Medida de la tarjeta interna: 7 x 10.5 cm, caja con 50 juegos.



GFT-10HC:

Porta gafete de PVC transparente horizontal con cordón.

Medida de la tarjeta interna: 10.5 x 7 cm, caja con 50 juegos.



Interno: 1 caja con 50 juegos c/u.
Corrugado: 40 cajas.

GFT-10VC



GFT-10HC



GFT-10

GFT-10V:

Porta gafete de PVC transparente vertical.

Medida de la tarjeta interna: 5.5 x 9 cm, caja con 50 juegos.



GFT-10H:

Porta gafete de PVC transparente horizontal.

Medida de la tarjeta interna: 9 x 5.5 cm, caja con 50 juegos.



Interno: 1 caja con 50 juegos c/u.
Corrugado: 40 cajas.

GFT-10V



GFT-10H



Portagafetes

GFA-12VC

Porta gafetes de plástico **sólido vertical con cordón**.
Medida de la tarjeta interna: 5.4 x 8.5 cm, caja con 12 juegos.



Interno: 6 cajas con 12 juegos c/u.
Corrugado: 24 cajas.



7 502286 767378

GFA-12HC

Porta gafetes de plástico **sólido horizontal con cordón**.
Medida de la tarjeta interna: 5.4 x 8.5 cm, caja con 12 juegos.



Interno: 6 cajas con 12 juegos c/u.
Corrugado: 24 cajas.



7 502286 767446

GFP-12VC

Porta gafetes de plástico **pastel vertical con cordón**.
Medida de la tarjeta interna: 5.4 x 8.5 cm, caja con 12 juegos.



Interno: 6 caja con 12 juegos c/u.
Corrugado: 36 cajas.



7 502286 767514

GFP-12HC

Porta gafetes de plástico **pastel horizontal con cordón**.
Medida de la tarjeta interna: 5.4 x 8.5 cm, caja con 12 juegos.



Interno: 6 caja con 12 juegos c/u.
Corrugado: 36 cajas.



7 502286 767552

Portagafetes

GFE-10VN

Porta gafetes de plástico **vertical con cordón**.
Medida de la tarjeta interna: 5.4 x 8.5 cm, caja con 10 juegos.



Interno: 20 bolsas con
10 juegos c/u.
Corrugado: 80 bolsas.



7 502286 767330

GFE-10HN

Porta gafetes de plástico **horizontal con cordón**.
Medida de la tarjeta interna: 5.4 x 8.5 cm, caja con 10 juegos.



Interno: 20 bolsas con
10 juegos c/u.
Corrugado: 80 bolsas.



7 502286 767347

YO-10

Porta gafetes tipo yoyo con cordón **retráctil**, bolsa con 10 piezas colores blanco, negro, azul y surtido.



Interno: 30 bolsas.
Corrugado: 120 bolsas.

YO-10



7 502212 173785

YO-10B



7 502237 302290

YO-10A



7 502212 175369

YO-10N



7 502212 175352

Yoyos

YO-10T

Porta gafetes tipo yoyo con cordón **retráctil**, bolsa con **10 piezas** colores traslúcidos negro, azul y surtido.



Interno: 30 bolsas.
Corrugado: 120 bolsas.

YO-10T



YO-10AT



YO-10NT



YO-02C

Porta gafetes tipo yoyo con cordón **retráctil**, blíster con **2 piezas cromadas**.



Interno: 12 blisters.
Corrugado: 240 blisters.



TCP-A4

Tabla plástica con clip y regla impresa, tamaño **carta**.



Interno: 12 pzas.
Corrugado: 72 pzas.



Tablas

M-133

Tabla plástica tamaño carta/oficio. Con gancho de metal y regla en el costado. En colores humo, azul claro y transparente.



Gancho de metal



Interno: 12 pzas.
Corrugado: 48 pzas.

M-133.1
Humo.



M-133.2
Azul claro.



M-133.3
Transparente.



M-134

Tabla plástica tamaño carta/oficio. Con gancho wire clip y regla en el costado. En colores humo, azul claro y transparente.



Gancho wire clip



Interno: 12 pzas.
Corrugado: 72 pzas.

M-134.1
Humo.



M-134.2
Azul claro.



M-134.3
Transparente.



M-137

Tabla plástica tamaño esquila. Con gancho wire clip y regla en el costado. En colores humo, azul claro y transparente.



Gancho wire clip



Interno: 24 pzas.
Corrugado: 120 pzas.

M-137.1
Humo.



M-137.2
Azul claro.



M-137.3
Transparente.



Tablas

TABLA MDF GANCHO

Tabla MDF en diferentes tamaños, **carta, oficio y esquila**. Con gancho de metal.



Gancho de metal



Interno: 12 pzas.
Corrugado: 48 pzas.

M-105.0
Tamaño carta.



M-107.0
Tamaño oficio.



Interno: 24 piezas.
Corrugado: 96 piezas.

M-106.0
Tamaño esquila.



TABLA MDF WIRE CLIP

Tabla MDF en diferentes tamaños, **carta, oficio y esquila**. Con gancho wire clip.



Gancho wire clip



Interno: 12 pzas.
Corrugado: 72 pzas.

M-109.0
Tamaño carta.



M-105.5
Tamaño oficio.



Interno: 24 piezas.
Corrugado: 120 piezas.

M-110.0
Tamaño esquila.



Tablas

M-123

Tabla de aluminio en tamaño carta. Con gancho wire clip y de metal.

M-123.0



Gancho wire clip

M-123.2



Gancho de metal



Interno: 12 pzas.
Corrugado: 48 pzas.

M-123.0



7 502277 586414

M-123.2



7 502277 586421

M-124

Tabla de aluminio en tamaño oficio. Con gancho wire clip y de metal.

M-124.0



Gancho wire clip

M-124.2



Gancho de metal



Interno: 12 pzas.
Corrugado: 48 pzas.

M-124.0



7 502277 588609

M-124.2



7 502277 588593

Bandejas

M-211

Bandeja sencilla en tamaño **oficio**. Medidas: 26 x 36 x 4 cm.



Corrugado: 12 pzas.

Colores:

M-211.1

Humo



M-211.4

Negro



M-211.1

Humo



7 502277 589279

M-211.4

Negro



7 502277 589286

M-284

Bandeja doble armable en tamaño **oficio**. Medidas: 26 x 36 x 13 cm.



Corrugado: 12 pzas.

Colores:

M-284.1

Humo



M-284.4

Negro



M-284.1

Humo



7 502277 589354

M-284.4

Negro



7 502277 589361

M-285

Bandeja triple armable en tamaño **oficio**. Medidas: 26.5 x 36.2 x 21.2 cm.



Corrugado: 8 pzas.

Colores:

M-285.1

Humo



M-285.4

Negro



M-285.1

Humo



7 502277 589378

M-285.4

Negro



7 502277 589385

Bandejas

M-243

Bandeja doble articulable en tamaño **oficio**. Medidas: 25.5 x 35.5 x 14.5 cm.



Colores:

M-243.1

M-243.4

Humo

Negro



M-243.1

M-243.4

Humo

Negro



Corrugado: 8 pzas.

M-245

Bandeja triple articulable en tamaño **oficio**. Medidas: 25.5 x 35.5 x 23.5 cm.



Colores:

M-245.1

M-245.4

Humo

Negro



M-245.1

M-245.4

Humo

Negro



Corrugado: 6 pzas.

Bandeja y organizadores

M-255

Bandeja lateral triple en tamaño carta. Medidas: 33.4 x 22.9 x 21.3 cm.



Colores:

M-255.1

Humo



M-255.4

Negro



M-255.1

Humo



7 502277 589330

M-255.4

Negro



7 502277 589347



Corrugado: 8 pzas.

M-936.0

Porta clips magnético traslúcido.
Medidas: 45 x 45 x 62 mm.



Interno: 20 pzas.
Corrugado: 180 pzas.



7 502277 586513

M-867.2

Exhibidor modular de pared.
Medidas: 33 x 10.7 x 20.2 cm.



Corrugado: 20 pzas.



7 502277 589460

Organizadores

M-740

Organizador de escritorio con despachador de cinta.
Medidas: 18.5 x 15.9 x 11 cm.



Colores:

M-740.0
Transparente



M-740.1
Humo



M-740.4
Negro



M-740.0
Transparente



M-740.1
Humo



M-740.4
Negro



Corrugado: 48 pzas.

M-940

Organizador de escritorio con 4 divisiones.
Medidas: 15 x 10 x 10.5 cm.



Colores:

M-940.0
Transparente



M-940.1
Humo



M-940.4
Negro



M-940.0
Transparente



M-940.1
Humo



M-940.4
Negro



Corrugado: 90 pzas.

M-941

Organizador de escritorio giratorio.
Medidas: 12 x 12 x 12 cm.



Colores:

M-941.0
Transparente



M-941.1
Humo



M-941.4
Negro



M-941.0
Transparente



M-941.1
Humo



M-941.4
Negro



Corrugado: 40 pzas.

M-977

Organizador de cajones de poliestireno, con varias divisiones, en colores negro y humo.
Medidas: 35.5 x 25.5 x 2.5 cm.



Colores:

M-977.1
Negro



M-977.5
Humo



M-977.1
Negro



M-977.5
Humo



Corrugado: 24 pzas.

Porta lápices y organizadores

M-933

Porta lápices con **dos divisiones**.
Medidas: 7 x 7 x 10 cm.



Colores:

M-933.1

Humo



M-933.4

Negro



M-933.1

Humo



M-933.4

Negro



Corrugado: 120 pzas.

7 502277 589484

7 502277 589491

M-934.4

Porta lápices **jumbo**.
Medidas: 8.5 x 7.6 x 10.8 cm.



Corrugado: 120 pzas.



7 502277 589477

M-864

Organizador vertical con
5 divisiones, ideal para cartas.
Set con **2 piezas**.
Medidas: 20.2 x 14 x 15.4 cm.

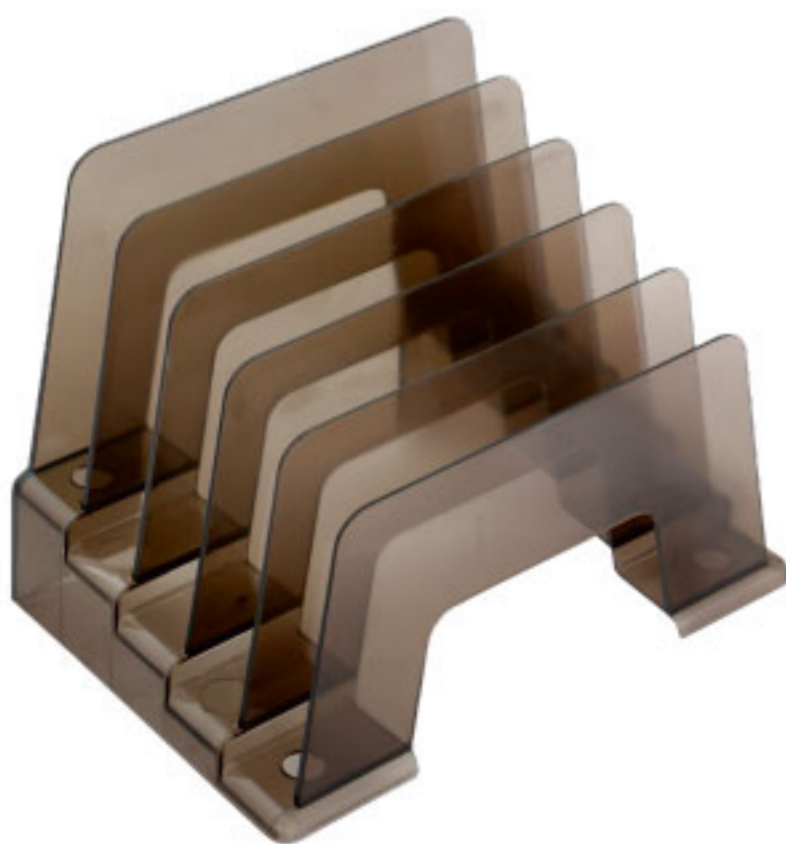

Colores:

M-864.0

Humo



M-864.4

Negro



M-864.0

Humo



M-864.4

Negro



Corrugado: 20 sets.

7 502277 589446

7 502277 589453

M-863

Exhibidor clásico de **documentos**.
Set con **2 piezas**.
Medidas: 23 x 8.3 x 25.5 cm.

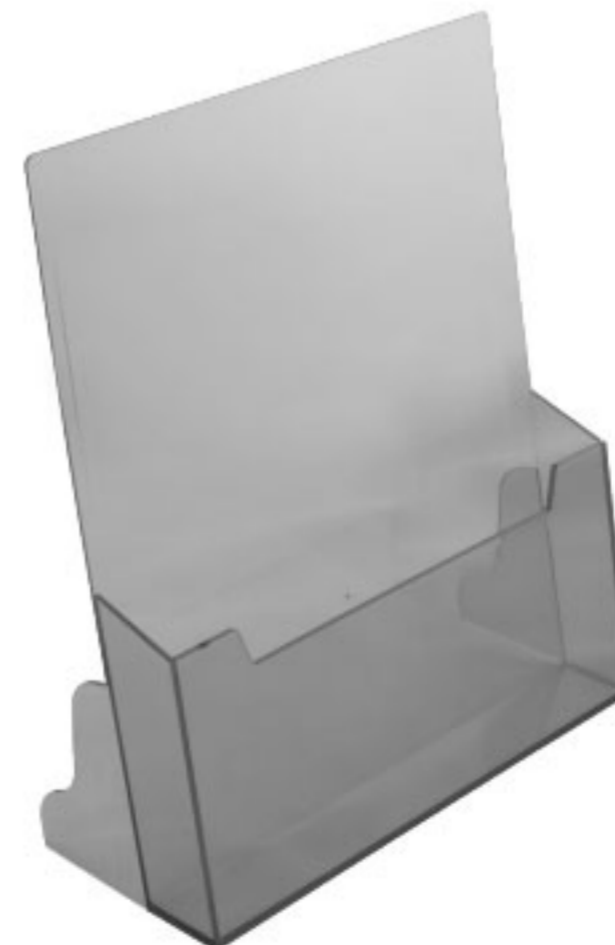

Colores:

M-863.0

Transparente



M-863.1

Humo



M-863.0

Transparente



M-863.1

Humo



Corrugado: 20 sets.

7 502277 589422

7 502277 589439

Llaveros

M-141.0

Bote con **24 llaveros** de polipropileno.
Colores surtidos y **etiquetas de identificación**.



Corrugado: 36 botes.



7 502277 586469

M-142.0

Bote con **60 llaveros** de polipropileno.
Colores surtidos y **etiquetas de identificación**.



Corrugado: 24 botes.



7 502277 586476

M-143.0

Soporte **organizador de llaves**, se fija con tornillos
o autoadhesivo.
Colores surtidos y **etiquetas de identificación**.



Interno: 12 pzas.
Corrugado: 72 pzas.



7 502277 586452

M-144.0

Bote con **120 llaveros** de polipropileno.
Colores surtidos y **etiquetas de identificación**.



Corrugado: 6 botes.



7 502277 586483

Indicador láser

M-571.2

Bote de basura. 12 litros.
Medidas: 29.5 x 27 x 30.5 cm.



Corrugado: 48 pzas.



7 502277 589569

RP-10N

Revistero de plástico resistente color negro.
Medidas: 25 x 29.5 x 8.3 cm.



Interno: 1 pza.
Corrugado: 36 pzas.



7 502212 171583

ILP-10 / ILN-10

Indicador láser con 3 diferentes proyecciones, color negro y plata. Incluye 2 punteros intercambiables y 2 pilas AAA.

ILP-10



ILN-10



Interno: 1 pza.
Corrugado: 50 pzas.



7 502212 178544 7 502212 178537

ILN-20

Indicador láser con 5 diferentes proyecciones, punta giratoria, color negro. Incluye 2 pilas AAA.



Punta Giratoria



Interno: 1 pza.
Corrugado: 50 pzas.



7 502265 160008

Organizadores mesh

PCM

Porta clips de malla.
Medidas: 11.5 x 4.8 x 11.5 cm.



Interno: 6 pzas.
Corrugado: 96 pzas.



7 502286 760140

PCM-CH

Porta clips de malla.
Medidas: 8.9 x 3.3 x 8.9 cm.



Interno: 6 pzas.
Corrugado: 120 pzas.



7 502286 762656

PLM

Porta lápices de malla.
Medidas: 9 x 10 x 9 cm.



Interno: 6 pzas.
Corrugado: 96 pzas.



7 502286 760157

PLM-G

Porta lápices de malla grande.
Medidas: 11.5 x 13.7 x 11.5 cm.



Interno: 6 pzas.
Corrugado: 48 pzas.



7 502286 760164

Organizadores mesh

ORM-3

Organizador de escritorio de 3 divisiones.
Medidas: 18.5 x 10 x 9.5 cm.



Corrugado: 24 pzas.



7 502286 760126

ORM-4

Organizador de escritorio de 4 divisiones.
Medidas: 27 x 16 x 4.6 cm.

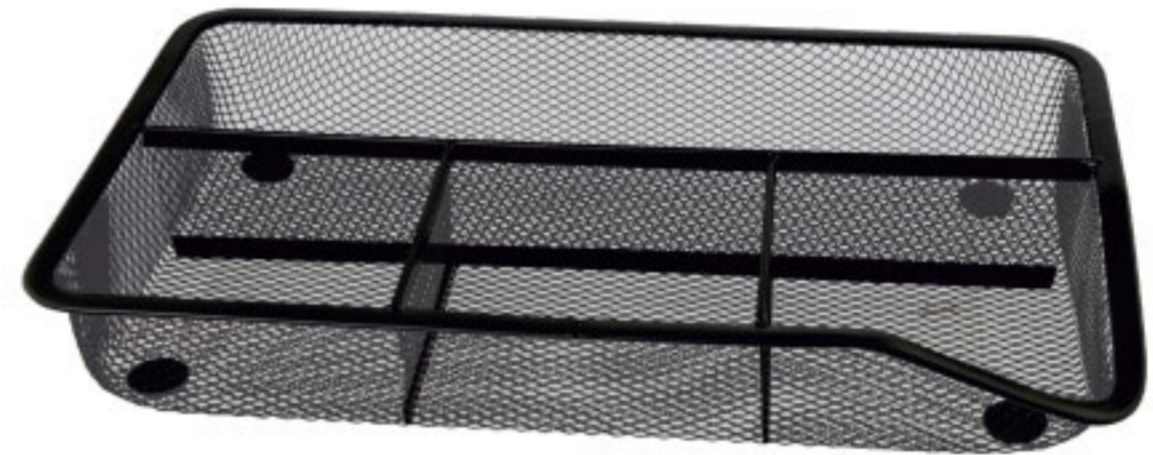

Corrugado: 36 pzas.



7 502286 760089

ORM-9

Organizador de escritorio de 9 divisiones.
Medidas: 22 x 10.4 x 11 cm.



Corrugado: 12 pzas.



7 502286 760119

PSM-3

Porta sobres de malla.
Medidas: 17.2 x 13 x 8 cm.



Interno: 6 pzas.
Corrugado: 72 pzas.



7 502286 760133

Organizadores mesh

BM-3

Bandeja de 3 niveles de malla. Medidas: 28 x 36.3 x 5.5 cm.

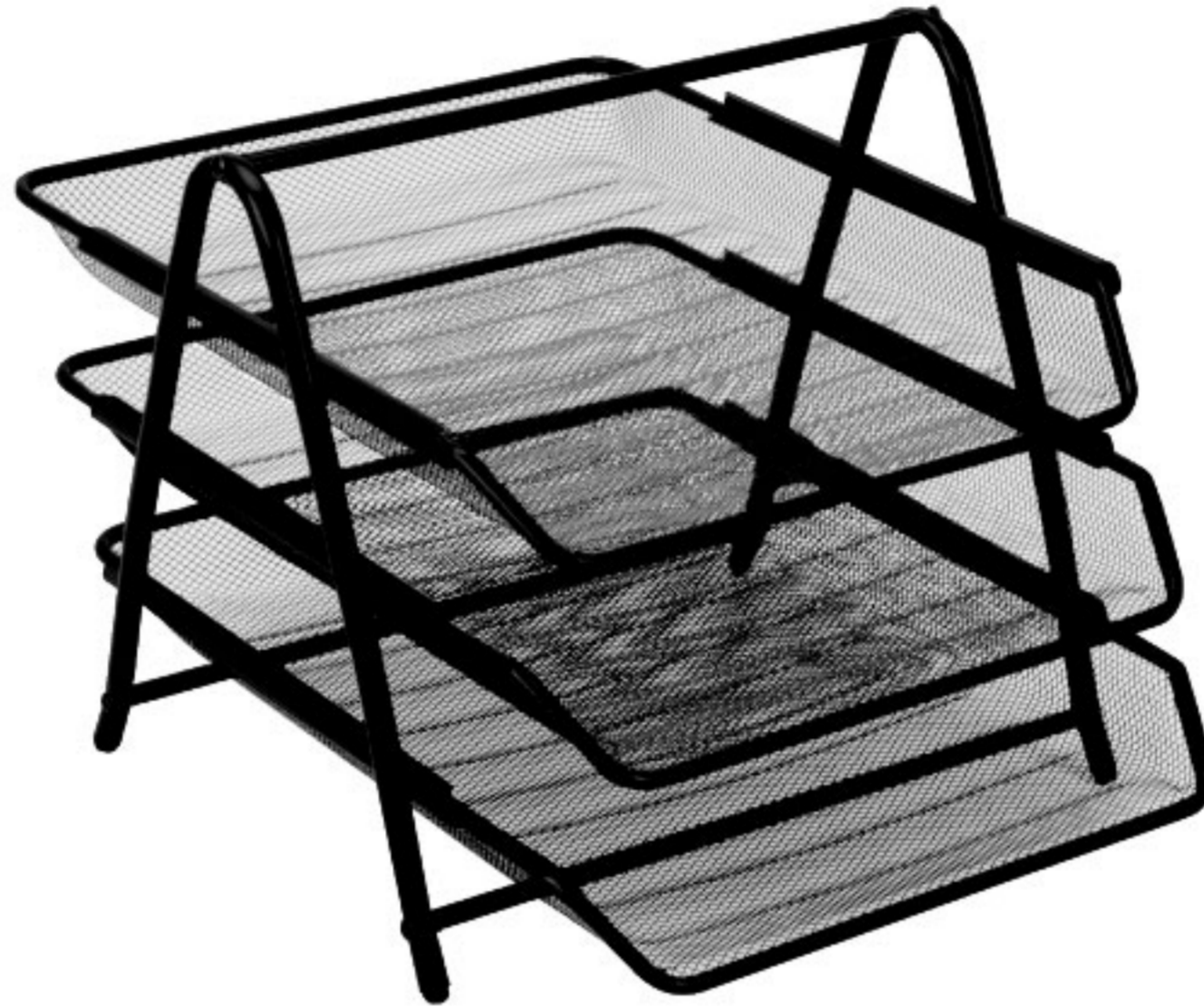

Corrugado: 10 pzas.



7 502286 760072

ME-4

Organizador de escritorio de 4 piezas. Medidas: 28.5 x 35.8 x 9 cm.

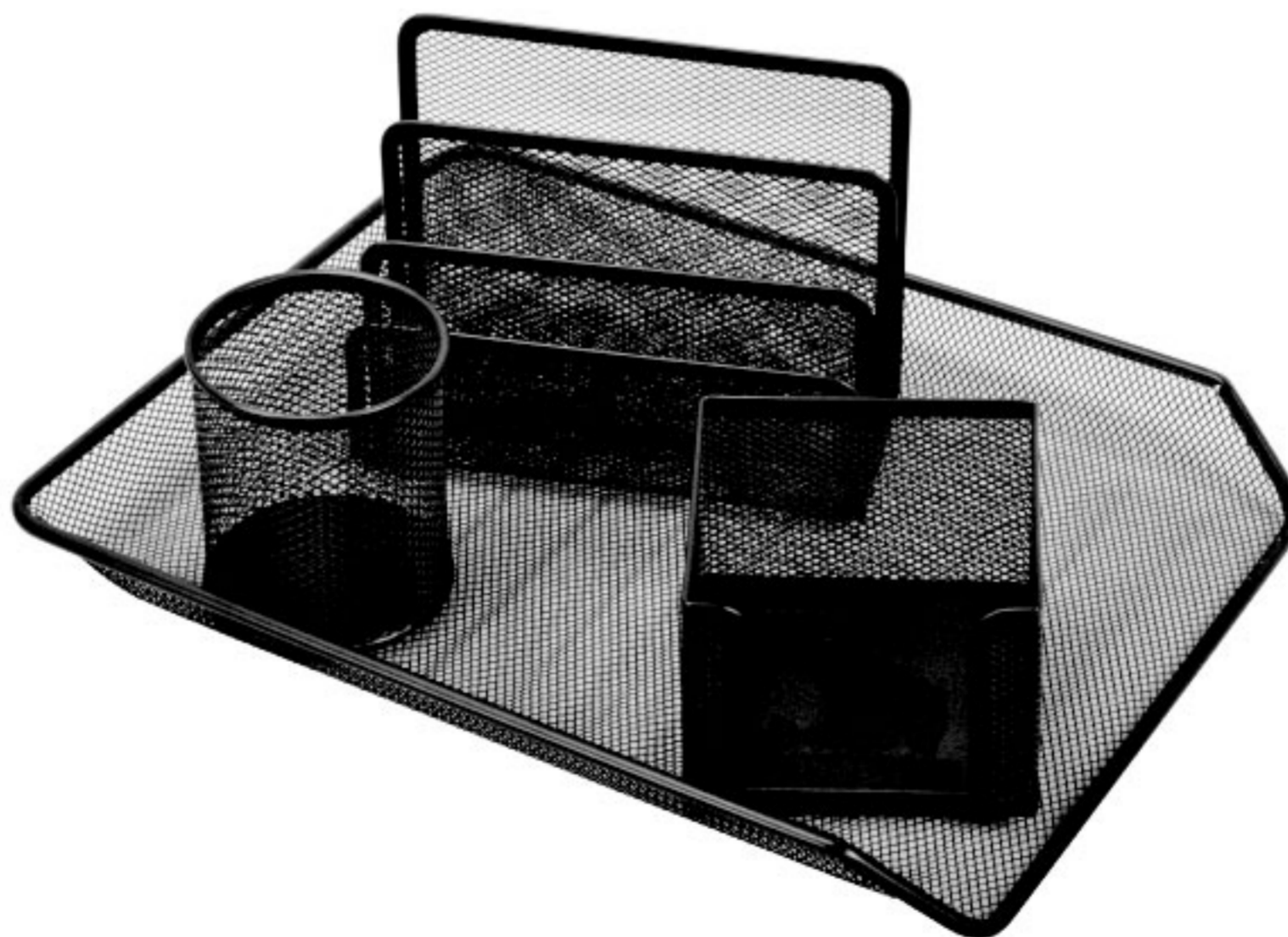

Corrugado: 6 pzas.



7 502212 175086

Bote de basura y cajas de archivo

BB-20

Bote para **basura** de **malla**. Medidas: 29.3 x 34.5 x 29.3 cm.



Corrugado: 12 pzas.



7 502212 171606

CCA-C

Caja de **archivo** de cartón corrugado,
para documentos tamaño **carta**.



Interno: 1 pza.
Corrugado: 20 pzas.



7 502237 309169

CCA-O

Caja de **archivo** de cartón corrugado,
para documentos tamaño **oficio**.



Interno: 1 pza.
Corrugado: 20 pzas.



7 502237 309183

Sillas

SSSBM-N

Silla secretarial giratoria, de tela de malla.
Altura ajustable.



Corrugado: 1 pza.



7 502237 302658

SSCBM-N

Silla secretarial giratoria, con descansa brazos,
de tela de malla. Altura ajustable.



Corrugado: 1 pza.



7 502237 302665

MINSIP

Mini silla plástica. Medidas: 53.5 x 32 cm.



Corrugado: 10 pzas.

MINSIP-RS



7 502212 177172

Marcos de aluminio

DB

DB-40



Corrugado: 1 pza.

- ✓ Fácil y práctica manipulación debido a su ligereza y empaque.
- ✓ Gracias a su superficie de PVC antifatiga ¡Puede **ahorrar** en el costo del acabado de sus impresiones!
- ✓ Sin riesgo de romperse gracias a sus materiales de aluminio y PVC.
No hay cristales.
- ✓ Juntas de acero **inoxidable**.

Marcos de aluminio

Ahorro en tiempo por su único mecanismo de colocación

DB-40

Medida interna: 85 x 60 cm

Altura: 120 cm

Ancho: 64 cm



7 502237 304621

DB-30



DB-30
Medida interna:
60 x 90 cm



7 502237 304614

DB-20



DB-20
Medida interna:
70 x 101 cm



7 502237 304607

DB-50



DB-50
Medida interna:
90 x 120 cm



7 502237 304638

DB-60



DB-60
Medida interna:
121 x 177 cm



7 502237 304645

ARTE Y MANUALIDADES

Pinceles

POP6

Pincel plano de pelo de cerdo para óleo. Del número 02 al 24.



Bolsa con 6 pinceles del mismo número.



POP12-S

Set de 12 pinceles del número 02 al 24.

POP12-S



Interno: 24 sets.
Corrugado: 72 sets.

POP6-02



Interno: 24 sets.
Corrugado: 360 sets.

POP6-20



Interno: 12 sets.
Corrugado: 60 sets.

POP6-24



Interno: 12 sets.
Corrugado: 72 sets.

POP6-16



Interno: 12 sets.
Corrugado: 72 sets.

POP6-22



Interno: 12 sets.
Corrugado: 72 sets.

POP6-12



Interno: 24 sets.
Corrugado: 120 sets.

POP6-14



Interno: 12 sets.
Corrugado: 120 sets.

POP6-18



Interno: 12 sets.
Corrugado: 120 sets.

POP6-04



Interno: 24 sets.
Corrugado: 240 sets.

POP6-06



Interno: 24 sets.
Corrugado: 240 sets.

POP6-08



Interno: 24 sets.
Corrugado: 240 sets.

POP6-10



Interno: 24 sets.
Corrugado: 240 sets.

Pinceles

POR6

Pincel redondo de pelo de cerdo para óleo. Del número 02 al 24.

-  POR6-02
-  POR6-04
-  POR6-06
-  POR6-08
-  POR6-10
-  POR6-12
-  POR6-14
-  POR6-16
-  POR6-18
-  POR6-20
-  POR6-22
-  POR6-24



Bolsa con 6 pinceles del mismo número.



POR12-S

Set de 12 pinceles del número 02 al 24.

POR12-S



7 502237 308278



Interno: 24 sets.
Corrugado: 72 sets.

POR6-02



7 502237 308148

POR6-04



7 502237 308155

POR6-06



7 502237 308162

POR6-08



7 502237 308179

POR6-10



7 502237 308186



Interno: 24 sets.
Corrugado: 240 sets.

POR6-12



7 502237 308193

POR6-14



7 502237 308209

POR6-16



7 502237 308216

POR6-18



7 502237 308223

POR6-20



7 502237 308230

POR6-22



7 502237 308247

POR6-24



7 502237 308254



Interno: 24 sets.
Corrugado: 216 sets.



Interno: 24 sets.
Corrugado: 120 sets.



Interno: 12 sets.
Corrugado: 60 sets.

Pinceles

PA6

Pincel de pelo de pony para acuarela. Del número 0 al 12.



Bolsa con 6 pinceles del mismo número.

PA6-0



Interno: 24 sets.
Corrugado: 480 sets.

PA6-01



PA6-02



PA6-03



PA6-04



PA6-05



PA6-11



Interno: 24 sets.
Corrugado: 144 sets.

PA6-12



PA6-06



Interno: 24 sets.
Corrugado: 240 sets.

PA6-07



PA6-08



PA6-09



PA6-10



Pinceles

PA12-S

Set de 12 pinceles de pelo de pony para acuarela, del número 01 al 12.



Interno: 12 sets.
Corrugado: 240 sets.



7 502237 308261

MAO-6S

Set con 2 pinceles para óleo y 4 para acuarela.



Interno: 24 sets.
Corrugado: 480 sets.



7 502237 308292

Pinceles

MAO-15S

Juego de pinceles surtidos para acuarela y óleo, en blíster.



Interno: 12 sets.
Corrugado: 48 sets.



7 502286 760003

PF-3S

Pincel de esponja en tres medidas diferentes:
25 mm, 50 mm y 75 mm en bolsa.



Interno: 12 sets.
Corrugado: 144 sets.



7 502286 760041

PBM-19

Pincel tipo brocha de 3/4" (19 mm), en blíster.



Interno: 36 blisters.
Corrugado: 432 blisters.



7 502286 760102

PBM-25

Pincel tipo brocha de 1" (25 mm), en blíster.



Interno: 36 blisters.
Corrugado: 432 blisters.



7 502286 760034

Pinceles

PER-3BL

Pincel escolar en tres tamaños diferentes, en blíster.



Interno: 24 blisters.
Corrugado: 144 blisters.



7 502286 760010

PPE-1BL

Pincel escolar en blíster.



Colores:



Interno: 12 blisters.
Corrugado: 216 blisters.



7 502286 760058

PSB-16

Bote con 72 pinceles escolares en juegos de 12 piezas del número 1 al 6.



Interno: 6 pzas.
Corrugado: 48 pzas.



7 502286 760027

PSB-712

Bote con 72 pinceles escolares en juegos de 12 piezas del número 7 al 12.



Interno: 6 pzas.
Corrugado: 36 pzas.



7 502286 760096

Pistolas y silicón

GGP-20

Pistola para silicón PREMIUM 20W chica.
Alto rendimiento y gran durabilidad.



- Con sistema PTC que maximiza y mantiene la temperatura con **AHORRO** de energía



Interno: 12 pzas.
Corrugado: 48 pzas.



7 502237 309589

GGP-40

Pistola para silicón PREMIUM 25W grande.
Alto rendimiento y gran durabilidad.



- Con sistema PTC que maximiza y mantiene la temperatura con **AHORRO** de energía



Interno: 12 pzas.
Corrugado: 24 pzas.



7 502237 309602

SBP-7ML

Barra de silicón PREMIUM de 7 mm de diámetro,
bolsa de 1 kilogramo.



Interno: 1 bolsa.
Corrugado: 25 bolsas.



7 502237 309626

SBP-11ML

Barra de silicón PREMIUM de 11 mm de diámetro,
bolsa de 1 kilogramo.



Interno: 1 bolsa.
Corrugado: 25 bolsas.



7 502237 309640

Silicón líquido

BLS-30

Silicón líquido, bote de 30 ml.



Máximo Rendimiento



Interno: 24 pzas.
Corrugado: 576 pzas.



7 502265 161166

BLS-60

Silicón líquido, bote de 60 ml.



Máximo Rendimiento



Interno: 24 pzas.
Corrugado: 288 pzas.



7 502265 162798

BLS-100

Silicón líquido, bote de 100 ml.



Máximo Rendimiento



Interno: 12 pzas.
Corrugado: 192 pzas.



7 502265 161173

BLS-250

Silicón líquido, bote de 250 ml.



Máximo Rendimiento



Interno: 12 pzas.
Corrugado: 72 pzas.



7 502265 161180

Diamantina con pegamento

DIP

Diamantina con pegamento, bote de 60 ml.



DIP-AZR
Azul rey



DIP-AZC
Azul claro



DIP-AZE
Azul eléctrico



DIP-AZP
Azul pastel



DIP-COB
Cobre



DIP-OC
Oro claro



DIP-DO
Dorado



DIP-AM
Amarillo



DIP-VEC
Verde claro



DIP-VEO
Verde oscuro

DIP-AZR



7 502265 162910

DIP-AZC



7 502265 163023

DIP-AZE



7 502265 162897

DIP-AZP



7 502265 163009

DIP-COB



7 502265 162958

DIP-OC



7 502265 162842

DIP-DO



7 502265 162927

DIP-AM



7 502265 163030

DIP-VEC



7 502265 162989

DIP-VEO



7 502265 162873



Interno: 6 pzas.
Corrugado: 96 pzas.

Diamantina con pegamento

DIP

Diamantina con pegamento, bote de 60 ml.



DIP-RSM
Rosa mexicano



DIP-FSA
Fucsia



DIP-LI
Lila



DIP-MO
Morado



DIP-PRS
Palo de rosa



DIP-NA
Naranja



DIP-RJ
Rojo



DIP-NE
Negro



DIP-PER
Perla



DIP-PL
Plata



DIP-MC
Multicolor

DIP-RSM



7 502265 162996

DIP-FSA



7 502265 162880

DIP-LI



7 502265 162972

DIP-MO



7 502265 162941

DIP-PRS



7 502265 162934

DIP-NA



7 502265 163016

DIP-RJ



7 502265 162866

DIP-NE



7 502265 162903

DIP-PER



7 502265 162965

DIP-PL



7 502265 163047

DIP-MC



7 502265 162859



Interno: 6 pzas.
Corrugado: 96 pzas.

Pegamento blanco

PBL

Pegamento blanco en bote de diferentes presentaciones: 40 g, 60 g, 125 g, 250 g, 500 g y 1.2 kg.

PBL-40



PBL-60



Corrugado: 100 pzas.



7 502286 767163



Corrugado: 100 pzas.



7 502277 588326

PBL-125



PBL-250



Corrugado: 70 pzas.



7 502277 588333



Corrugado: 40 pzas.



7 502277 588340

PBL-500



PBL-1000



Corrugado: 24 pzas.



7 502277 588357



Corrugado: 12 pzas.



7 502277 588364

Diamantina entera

MDE-BL6010S

Diamantina entera. Blíster con 60 bolsas de 10 g c/u.
Colores surtidos.



Corrugado: 16 blisters.

MDE-BL6010S

7502277582652

MDE-2510

Diamantina entera. Paquete con 25 bolsas de 10 g c/u.



MDE-2510RJ
Rojo



MDE-2510PL
Plata



MDE-2510OR
Oro



Corrugado: 24 paquetes.

MDE-2510OR 7502277582843

MDE-2510PL 7502277582850

MDE-2510RJ 7502277582867

MDE-1010

Diamantina entera. Paquete con 10 bolsas de 10 g c/u.



MDE-1010PL
Plata



MDE-1010OB
Morado obispo



MDE-1010CA
Café



MDE-1010MO
Morado



MDE-1010NA
Naranja



MDE-1010VL
Verde limón



MDE-1010RS
Rosa



MDE-1010OR
Oro



MDE-1010LI
Lila

MDE-1010OR 7502277582683

MDE-1010OB 7502277582768

MDE-1010PL 7502277582669

MDE-1010VL 7502277582782

MDE-1010MO 7502277582805

MDE-1010RS 7502277582836

MDE-1010CA 7502277582812

MDE-1010NA 7502277582829

MDE-1010LI 7502277582799



Corrugado: 60 paquetes.

Diamantina fina

MDF-BL6010S

Diamantina fina. Blíster con 60 bolsas de 10 g c/u, colores surtidos.



Corrugado: 16 blisters.

MDF-BL6010S

7502277582409

MDF-2510

Diamantina fina. Paquete con 25 bolsas de 10 g c/u.



MDF-2510OR

Oro



MDF-2510PL

Plata



MDF-2510RJ

Rojo

MDF-2510OR 7502277583291

MDF-2510PL 7502277583307

MDF-2510RJ 7502277583314



Corrugado: 24 paquetes.

MDF-1010

Diamantina fina. Paquete con 10 bolsas de 10 g c/u.



MDF-1010NG

Negro



MDF-1010FS

Fucsia



MDF-1010VE

Verde



MDF-1010BL

Blanco



MDF-1010AM

Amarillo



MDF-1010CE

Azul cielo



MDF-1010OB

Morado obispo



MDF-1010MO

Morado



MDF-1010AR

Azul rey



MDF-1010PL

Plata



MDF-1010OR

Oro



MDF-1010RJ

Rojo

MDF-1010NG 7502277583161

MDF-1010FS 7502277583178

MDF-1010VE 7502277583147

MDF-1010BL 7502277583185

MDF-1010OB 7502277583215

MDF-1010PL 7502277583116

MDF-1010RJ 7502277583123

MDF-1010OR 7502277583130

MDF-1010MO 7502277583253

MDF-1010AM 7502277583222

MDF-1010AR 7502277583154

MDF-1010CE 7502277583208



Corrugado: 60 paquetes.

Diamantina fina

MDF-BL205

Diamantina fina. Blíster con 20 bolsas de 5 g c/u.



MDF-BL205S Surtido básico
 MDF-BL205SC Surtido claro
 MDF-BL205SO Surtido oscuro
 MDF-BL205SF Surtido fluorescente
 MDF-BL205SN Surtido nacarado



Corrugado: 30 blisters.

MDF-BL205S	7502277582416	MDF-BL205SC	7502277582874
MDF-BL205SO	7502277582881	MDF-BL205SF	7502277582898
MDF-BL205SN	7502277582904		

MDF-BL105

Diamantina fina. Blíster con 10 bolsas de 5 g c/u.



MDF-BL105S Surtido básico
 MDF-BL105SC Surtido claro
 MDF-BL105SO Surtido oscuro
 1 color



MDF-BL105OR	7502277582935	MDF-BL105SO	7502277583109	MDF-BL105S	7502277582423	MDF-BL105SC	7502277583093
MDF-BL105FS	7502277582973	MDF-BL105VE	7502277582942	MDF-BL105PL	7502277582911	MDF-BL105RJ	7502277582928
MDF-BL105OB	7502277583017	MDF-BL105BL	7502277582980	MDF-BL105AR	7502277582959	MDF-BL105NG	7502277582966
MDF-BL105MO	7502277583055	MDF-BL105AM	7502277583024	MDF-BL105TQ	7502277582997	MDF-BL105CE	7502277583000
MDF-BL105CA	7502277583062	MDF-BL105VL	7502277583031	MDF-BL105RS	7502277583079	MDF-BL105LI	7502277583048



Corrugado: 60 blisters.

Limpiapipas

L100

Limpiapipas. Bolsa con 100 piezas.



L100-AZC
Azul claro



L100-AZ
Azul



L100-AZR
Azul rey



L100-RS
Rosa



L100-LI
Lila



L100-FSA
Fucsia

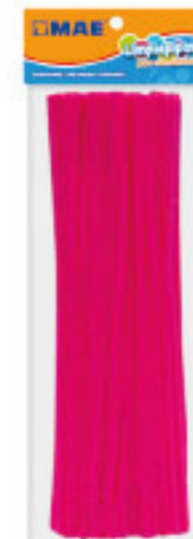

L100-RSO
Rosa oscuro



L100-MO
Morado



L100-AM
Amarillo



L100-NA
Naranja



L100-RJ
Rojo



L100-NE
Negro



L100-CA
Café



L100-DZ
Durazno



L100-VC
Verde claro



L100-VE
Verde



L100-VO
Verde oscuro



L100-BL
Blanco



L100-S
Surtido

L100-AZC



L100-AZ



L100-AZR



L100-RS



L100-LI



L100-FSA



L100-RSO



L100-MO



L100-AM



L100-NA



L100-RJ



L100-NE



L100-CA



L100-DZ



L100-VC



L100-VE



L100-VO



L100-BL



L100-S



Interno: 1 bolsa.
Corrugado: 100 bolsas.

Limpiapipas metálicos

L100M

Limpiapipas metálicos. Bolsa con 100 piezas.



L100M-VE
Verde metálico



L100M-RJ
Rojo metálico



L100M-MO
Morado metálico



L100M-DO
Dorado



L100M-PL
Plateado



L100M-FSA
Fucsia metálico



L100M-AZ
Azul metálico



L100M-AM
Amarillo metálico



L100M-S
Surtido metálico

L100M-PL



7 502265 168981

L100M-VE



7 502265 169018

L100M-RJ



7 502265 169001

L100M-MO



7 502265 169469

L100M-DO



7 502265 168998

L100M-FSA



7 502265 169452

L100M-AZ



7 502265 169445

L100M-AM



7 502265 169438

L100M-S



7 502265 169476



Interno: 1 bolsa.
Corrugado: 100 bolsas.

Pompones

POM

Pompones de colores.

POM-13
Medida: 13 mm



POM-19
Medida: 19 mm



POM-45
Medida: 45 mm



POM-25
Medida: 25 mm



POM-38
Medida: 38 mm



POM-13



7 502265 169964

POM-19



7 502265 169971

POM-25



7 502265 169988

POM-38



7 502265 169995

POM-45



7 502277 580023



Interno: 1 bolsa.
Corrugado: 500 bolsas.



Interno: 1 bolsa.
Corrugado: 100 bolsas.



Interno: 1 bolsa.
Corrugado: 50 bolsas.

Tijeras con patrón

TCF

Tijeras de punta redondeada con patrón de corte.



Colores:



TCF-01 Zig Zag



TCF-02 Curvas



TCF-03 Ondas



TCF-04 Zipper



TCF-05 Colonial



TCF-06 Gótico



TCF-01



TCF-02



TCF-03



TCF-04



TCF-05



TCF-06



Interno: 12 blisters.
Corrugado: 144 blisters.

TCF-BL4S

Tijeras de punta redondeada con patrón de corte. Blíster con 4 piezas, puntas intercambiables.



Interno: 12 blisters.
Corrugado: 72 blisters.



Chaquira

Chaquira

Chaquira, chaquirón y canutillo en colores surtidos. Blíster con 10 y 60 bolsas.

Práctica bolsa resellable

10 bolsas

8 bolsas



MCA-BL107S



MCH-BL1010S



MCN-BL1010S



MCH-BL810SM



MCN-BL810SM

MCA-BL107S	7502277582553
MCH-BL1010S	7502277582577
MCN-BL1010S	7502277582591
MCH-BL810SM	7502286765138
MCN-BL810SM	7502286765145



Corrugado: 60 blísters

Canutillo

Chaquira

Chaquirón



MCA-BL607S



MCH-BL6010S



MCN-BL6010S

MCA-BL607S



7 502277 582560

MCH-BL6010S



7 502277 582584

MCN-BL6010S



7 502277 582607



Corrugado: 18 blísters

Lentejuela

Lentejuela

Lentejuela de colores surtidos, tamaño mediano, grande y jumbo. Blísters de 10 y 60 bolsas.

10 bolsas



MLM-BL10S
Mediano



Corrugado: 70 blisters.



MLG-BL10S
Grande



Corrugado: 70 blisters.



MLJ-BL10S
Jumbo



Corrugado: 60 blisters.

60 bolsas



MLM-BL60S

MLM-BL60S
Mediano



Corrugado: 54 blisters.



MLG-BL60S

MLG-BL60S
Grande



Corrugado: 54 blisters.



MLJ-BL60S

MLJ-BL60S
Jumbo



Corrugado: 50 blisters.

Cuenta dona y ojos

Cuenta dona

Cuenta dona traslúcida, sólida y nacarada. Blíster con 10 y 60 bolsas.



Sólida



10 bolsas

MCD-BL10SS

MCD-BL10SS



7 502277 582614

Nacarada



MCD-BL10SN

MCD-BL10SN



7 502277 582621

Sólida



60 bolsas

MCD-BL60SS

MCD-BL60SS



7 502277 582638

Traslúcida y nacarada



MCD-BL60SNT

MCD-BL60SNT



7 502277 582645



Corrugado: 60 blisters.



Corrugado: 38 blisters.

Ojitos

Ojitos para manualidades en diferentes tamaños de forma redonda y ovalada.



Ovalados

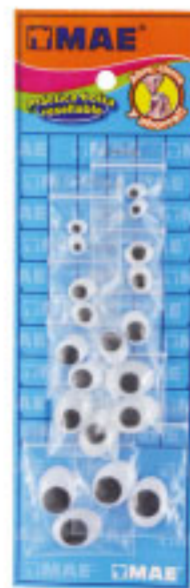

10 bolsas

MOO-BL10S



7 502277 583406

Redondos

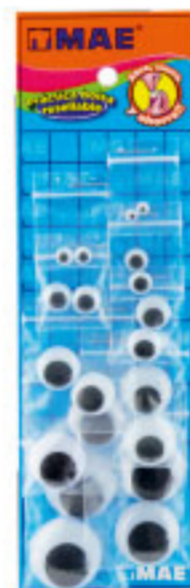

10 bolsas

MOR-BL10S



7 502277 583413

Ovalados



72 bolsas

MOO-BL72S



7 502277 583383

Redondos



64 bolsas

MOR-BL64S



7 502277 583390



Corrugado: 120 blisters.

Corrugado: 100 blisters.

Corrugado: 90 blisters.

Corrugado: 60 blisters.

Foamy

FYM

Foamy de colores surtidos, ideal para trabajos manuales y escolares.

Tamaño carta (21.5 x 28 cm), paquete con 24 piezas. Tamaño cartulina (45 x 60 cm) y pliego (70 x 95 cm), paquetes con 10 piezas.



Tamaño: carta



Surtido

	FYM-CAMC24	FYM-CCA24	FYM-CAZ24	FYM-CCE24	FYM-CLI24
FYM-CMG24	FYM-CRJQ24	FYM-CGC24	FYM-CAMO24	FYM-CRS24	FYM-CAQ24
FYM-CVC24	FYM-CRJ24	FYM-CBG24	FYM-CG24	FYM-CC24	FYM-CAZO24
	FYM-CCR24	FYM-CVE24	FYM-CVN24	FYM-CVO24	FYM-CUV24



Corrugado: 40 paquetes.

Tamaño: cartulina

				FYMCR-VN	FYMCR-GC
FYMCR-G	FYMCR-NA	FYMCR-CA	FYMCR-LI	FYMCR-AM	FYMCR-AQ
FYMCR-AZ	FYMCR-AMC	FYMCR-RSC	FYMCR-AMO	FYMCR-RS	FYMCR-AZO
FYMCR-VC	FYMCR-MO	FYMCR-BG	FYMCR-CH	FYMCR-C	FYMCR-CO
	FYMCR-CR	FYMCR-VO	FYMCR-CM	FYMCR-RJQ	FYMCR-UV



Corrugado: 20 paquetes.

Tamaño: pliego

					FYM-PAQ
FYM-PG	FYM-PRSC	FYM-PBG	FYM-PAMO	FYM-PC	FYM-PAO
FYM-PMG	FYM-PRJQ	FYM-PLI	FYM-PCH	FYM-PS	FYM-PZR
	FYM-PCRZ	FYM-PAMC	FYM-PGC	FYM-PCO	FYM-PUV



Corrugado: 20 paquetes.

Foamy diamantado

FDM

Foamy diamantado de colores surtidos, ideal para trabajos manuales y escolares.

Tamaño carta (21.5 x 28 cm), paquete con 10 piezas. Tamaño 4 cartas (43 x 56 cm) con 10 piezas.



Amarillo (AM)



Naranja (NA)



Turquesa (TQ)



Canela (CA)



Aqua (AQ)

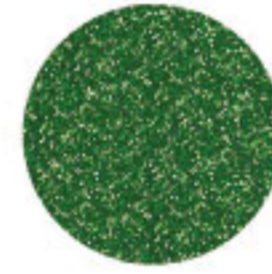

Verde limón (VL)



Azul cielo (CE)

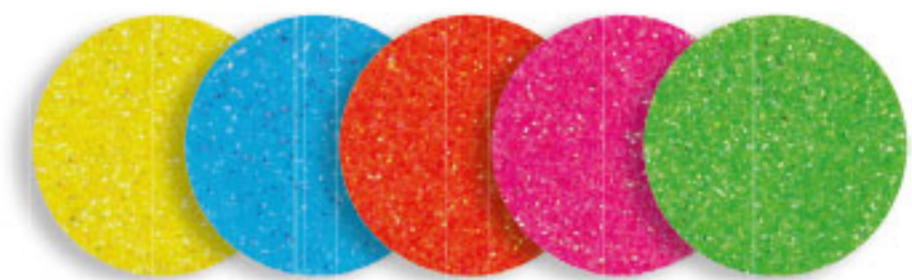

Surtido neón

Tamaño: carta

FDMC-AM10

FDMC-SN10

FDMC-AQ10

FDMC-VL10

FDMC-CE10

FDMC-NA10



Corrugado: 200 paquetes.

Tamaño: 4 cartas

FDM4-AM10

FDM4-CA10

FDM4-AQ10

FDM4-VL10

FDM4-CE10

FDM4-TQ10

FDM4-NA10



Corrugado: 60 paquetes.

Foamy iridiscente y Fieltro

Foamy iridiscente

Foamy iridiscente de colores surtidos, ideal para trabajos manuales y escolares. Tamaño carta (21.5 x 28 cm) y 4 cartas (43 x 56 cm) en paquetes con 10 piezas.



Blanco (B)



Rosa (RS)



Rosa Mexicano (RSM)



Naranja (NA)

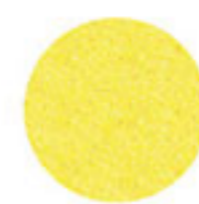

Amarillo (AM)



Mango (AMM)



Coral (CL)



Morado (MO)



Azul (AZ)



Celeste (CE)



Lila (LI)



Corrugado: 200 paquetes.

Tamaño: carta

FRMC-RS10	7502277588104	FRMC-MO10	7502277588159	FRMC-LI10	7502277588180	FRMC-AM10	7502277588135	FRMC-NA10	7502277588128	FRMC-AZ10	7502277588166
-----------	---------------	-----------	---------------	-----------	---------------	-----------	---------------	-----------	---------------	-----------	---------------



Corrugado: 60 paquetes.

Tamaño: 4 cartas

FRM4-NA10	7502277588234	FRM4-AM10	7502277588241	FRM4-B10	7502277588203	FRM4-MO10	7502277588265	FRM4-RS10	7502277588210
FRM4-AZ10	7502277588272	FRM4-CE10	7502277588289	FRM4-LI10	7502277588296	FRM4-AMM10	7502277588302		

Fieltro

Fieltro de colores surtidos, ideal para trabajos manuales y escolares. Tamaño carta (21.5 x 28 cm), en paquetes surtidos con 12 piezas.



Surtido (S)



Pastel surtido (PS)



Corrugado: 40 paquetes.

FEC-12S	7502286764704
FEC-12PS	7502286764711



SOLUCIONES DE DISTRIBUCIÓN INTEGRAL S.A DE C.V

México

Barranca Honda S/N Lote 84, Col. San Martín Obispo
Tepetlixpa, Cuautitlán Izcalli, Estado de México, C.P. 54763,
México. R.F.C. SDI020111RA0 Tel. 52(55) 5887-8686
Lada sin costo: 01-800-733-8926
www.mae.com.mx / clientes@mae.com.mx

Colombia

Autopista Medellín km 7, Celta Trade Park 44-2.
Funza, Colombia. NIT: 900.511.053-8 Tel. 3006471604
www.mae.com.co / clientescolombia@mae.com.mx

Edición 2025